

PORSCHE

*911 Carrera*

*911 Turbo*

Driver's Manual



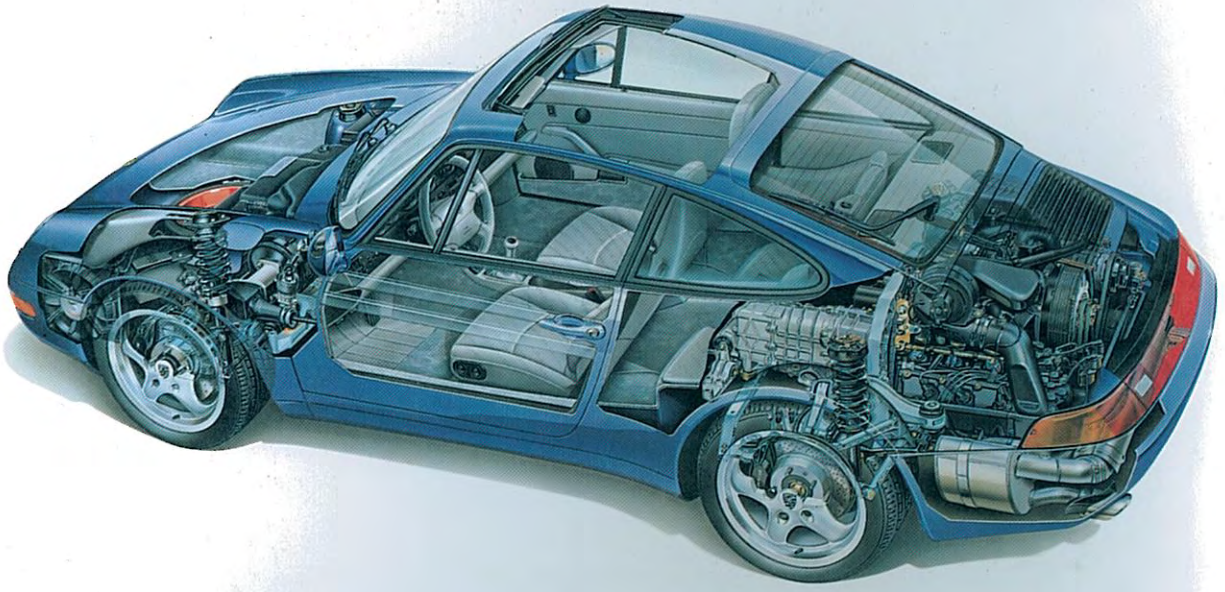

**Dear customer,**

we thank you for the confidence you have shown in buying this car and congratulate you on your new Porsche.

Your Porsche has been manufactured to the very highest standards of design and product technology.

Not only is your Porsche a lively sports car, but also a reliable vehicle for day-to-day driving which will give you much pleasure.

Always keep the glovebox literature in the car, and give it to the new owner when you sell your vehicle.

In this Driver's Manual you will find all you need to know about your Porsche.

The booklet entitled "Guarantee & Maintenance" gives you, your Official Porsche Centre and the next owner of your Porsche a useful indication as to the carrying out of servicing work.

To protect the validity of your guarantee, you must ensure that the prescribed services are carried out by specialists using genuine spare parts in an Official Porsche Centre.

We would also advise you to have your vehicle serviced at the intervals suggested even after your warranty has lapsed. Your Porsche will serve you all the better for that. The re-sale value of your vehicle and its part-exchange value at your Official Porsche Centre will likewise be all the better.

A worldwide after-sales service organisation is at the ready.

**Dr. Ing. h.c. F. Porsche  
Aktiengesellschaft**



© Dr. Ing. h.c. F. Porsche Aktiengesellschaft  
Printed in Germany

No part of this publication may be reprinted without our prior consent.

Because our vehicles undergo continuous development, equipment and specification may not be as illustrated or described in this Driver's Manual.

You will find further important information in the transparent plastic pocket inside the rear cover of this Driver's Manual.

Some of the equipment described in the Driver's Manual is optional. Your Official Porsche Centre will be pleased to advise you on retrofitting. Should your Porsche be fitted with equipment not described in this Manual, your Official Porsche Centre will be pleased to provide information concerning correct operation and care of these items.

Because of different legal requirements in the individual countries, the equipment of your vehicle may vary slightly from that described in this Driver's Manual.



## Important

Please use only Original Porsche Parts for your car. You can order such items from your Official Porsche Centre who will be conversant with the range of approved items and will be pleased to advise you further.

Porsche accepts responsibility, in accordance with its legal obligations, for Genuine Porsche Parts and for parts and accessories which it has approved for your car. But the use of other parts or accessories which are neither Genuine Porsche Parts nor approved by Porsche may adversely affect the safety of your car and Porsche can take no responsibility for any loss or damage caused by their use.

Even if the supplier of other accessories or parts is a recognized supplier, the safety of your car may still be affected if such items are installed. Due to the large variety of products offered in the accessory market it is not possible for Porsche to inspect and approve every one.

In addition, please note that the use of replacement parts which are not Genuine Porsche Parts or approved parts or the use of accessories not approved by Porsche may also detrimentally affect the Warranties relating to your car.

Technical modifications should only be carried out on your car if approved by Porsche.

This ensures that your Porsche remains safe from a functional and a driving point of view, and that it is not damaged as a result of the modifications.

Your Official Porsche Centre will be happy to advise you.

## Fuel Octane Rating

The engine is designed to provide optimum performance and fuel consumption if unleaded premium fuel, minimum 98 RON / 88 MON is used.

If unleaded premium fuels with octane numbers of at least 95 RON / 85 MON are used, the engine's knock control system automatically adapts the ignition timing.

## Tyre Pressures

Tyres cold, in bar overpressure (psi)

		Carrera	Turbo
<b>Summer tyres</b>			
Front	16" wheels	2.5 (36)	2.5 (36)
	17" wheels	2.5 (36)	
	18" wheels	2.5 (36)	
Rear	16" wheels	3.0 (44)	3.0 (44)
	17" wheels	2.5 (36)	
	18" wheels	3.0 (44)	
<b>Winter tyres</b>			
Front	16" wheels	2.5 (36)	2.5 (36)
	17" wheels	2.5 (36)	
Rear	16" wheels	3.0 (44)	3.0 (44)
	17" wheels	2.5 (36)	
<b>Collapsible spare tyre</b>	front and rear	2.5 (36)	2.5 (36)

These pressures only apply for tyre makes and types approved by Porsche.  
It is absolutely essential to comply with the instructions in the section "Tyres and Tyre Care".



**Before Driving Off, Running In, Controls**

**8 – 78**

**Maintenance, Car Care**

**79 – 95**

**Practical Tips, Minor Repairs**

**97 – 120**

**Vehicle Identification, Technical Data**

**121 – 140**

**Index**

**141 – 144**

**Pocket for additional information**

## Before Driving Off, Running In, Controls

Before Driving Off.....	8	Instruments,	
Running In.....	8	Warning and Control Lights.....	38 – 49
Keys.....	10 – 13	On-board Computer.....	48, 49
Doors, Power Windows.....	13	Light Switch.....	50, 51
Immobilizer, Central Locking,		Wash/Wipe Switch.....	52
Alarm System.....	14 – 16	Tempostat.....	53
Central Locking.....	17	Heated Rear Window, Heated Outside Mirror,	
Theft Protection, Alarm System.....	18	Fog Lamps, Cigarette Lighter.....	54
Passenger Compartment Monitoring.....	19	Rear Window Wiper,	
Interior Lights.....	19, 20	Hazard Warning Lamp Switch.....	55
Rear-view Mirror.....	21	Ashtray, Glove Compartment,	
Seats.....	22, 23	Storage Compartment in Door.....	56
Seat Belts, Child Restraint System.....	24, 25	Sun visors.....	57
Airbag System.....	26, 27	Heating, Ventilation,	
Handbrake, Footbrake.....	28	Air Conditioning System.....	58 – 60
ABS (Anti-lock Brake System).....	29	Particle Filter.....	60
ABD (Automatic Brake Differential).....	30	Manual Transmission, Clutch.....	61
Dynamic Four-Wheel Drive.....	31, 32	Tiptronic S.....	62 – 66
Rear Spoiler.....	33	Front Lid.....	67
Switches, Dashboard, Instruments.....	34 – 60	Rear Lid.....	68
Starting and Stopping the Engine.....	35, 36	Sun Roof.....	69
Ignition / Starter Switch with Steering Lock ...	36	Targa.....	70 – 72
Central Information System.....	38 – 40	Cabriolet.....	73 – 78



## Before Driving Off

For your own safety, before a journey you should check:

air pressure and condition of all tyres;

cleanliness of headlight lenses, rear lights, indicators and windows;

operation of headlights, brake lights and indicators with the ignition switched on;

operation of warning lights with ignition switched on and engine switched off;

that fuel supply is adequate;

adjustment of inside and outside rear-view mirrors for proper vision to the rear;

that seat belts are fastened - driver and passengers.

Have the fluid levels checked regularly, also between the prescribed maintenance intervals.

## Tips for Running In

There are no particular rules to be observed when running in your new Porsche. However, the following tips will be helpful in obtaining optimum engine operation.

Despite the most modern, high-precision manufacturing methods, it cannot be completely avoided that the moving parts have to wear in with each other. This wearing-in occurs mainly in the first 1000 km (600 miles).

The oil consumption may be somewhat higher than normal during the running-in period.

### Therefore you should:

Never overrev a cold engine, either in neutral or in gear.

Continually change the engine speed and the demands made upon the entire drive train. Do not exceed approx. 5000 rpm in the individual gears.

Always change gear in good time, and thereby keep the engine in the optimum revolution range (note the transmission diagram). This of course also applies after running-in.

## Bedding in new brake pads

New brake pads have to be bedded in, and do not therefore have full braking ability at the beginning. To compensate for this slightly reduced braking ability for approx. the first 200 km (120 miles) a little more pedal pressure is necessary. This also applies after having the brake discs renewed at a later date.

## Running in new tyres

Please note: new tyres do not at first possess their full road-holding ability. You should therefore break in new tyres by driving at moderate speeds for the first 100 to 200 km (60 to 120 miles).

## Maximum engine speed

Under normal driving conditions you should change into a higher gear before the needle reaches the red mark on the tachometer, or ease off the accelerator.

When maximum engine speed is reached, fuel feed is interrupted. This is to prevent overrevving of the engine when accelerating.



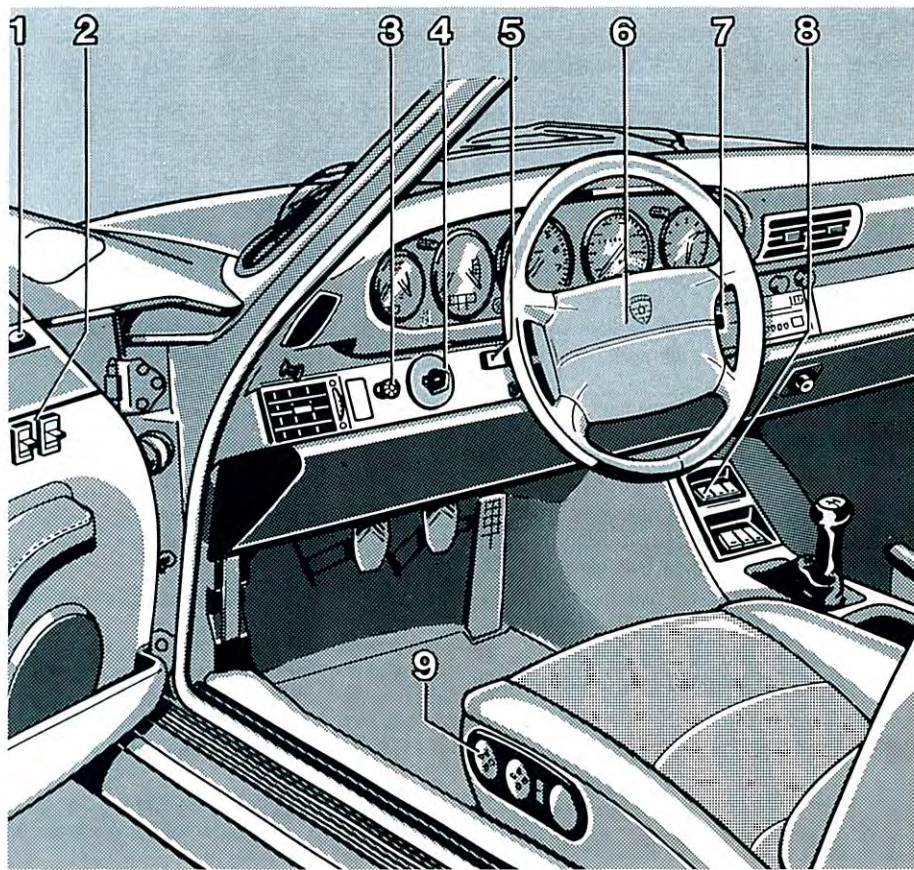

1. Door mirror control
2. Power window controls
3. Light switch
4. Ignition / starter switch with steering lock
5. Indicator / high beam / dipped beam / parking light / headlight flasher stalk
6. Horn
7. Windscreen wiper / washer stalk
8. Hazard warning light switch
9. Power seat controls



## Keys

Please note chapter "Immobilizer, Central Locking, Alarm System".

Three identically cut keys come with your Porsche.

Using these keys, you can operate the following items:

1. Vehicles with immobilizer:  
Door lock only for emergency operation of
  - Central Locking
  - Alarm system

Vehicles without immobilizer:

- Door lock in combination with
  - Central Locking
  - Alarm system
2. Ignition/starter switch with steering lock
3. Release handle for luggage compartment lock (Cabriolet)
4. Glove compartment lock

## Key card

Together with your car keys, you will also receive the key card. Keep this key card at a safe place outside the vehicle. When selling the vehicle, please pass the key card on to the buyer.

The key card contains:

- the key number
- the vehicle identification number
- the four-digit code number (framed) required for emergency unlocking of the immobilizer and setting of remote controls

In order to produce replacement keys, your Official Porsche Centre will require the vehicle identification number and the key number.

If wheels are to be removed while your vehicle is in a garage, please remember to hand over the socket for the security wheel nuts along with the main key.

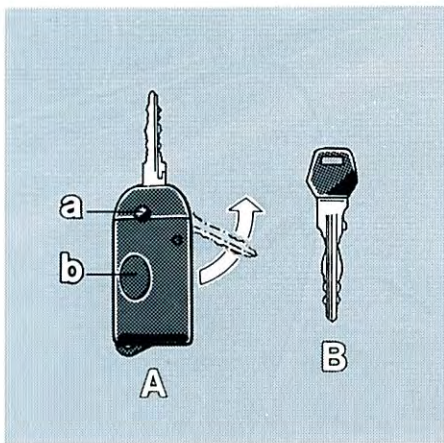

A - Key with integrated remote control  
 B - Flat key  
 a - Button to open the key bit  
 b - Remote control button

### Vehicles with immobilizer

The remote control for the central locking system, the alarm system and the immobilizer is integrated into the grip of key "A".

Open the key bit - press "a" button.

Close the key bit - press "a" button and fold the bit into the housing manually.

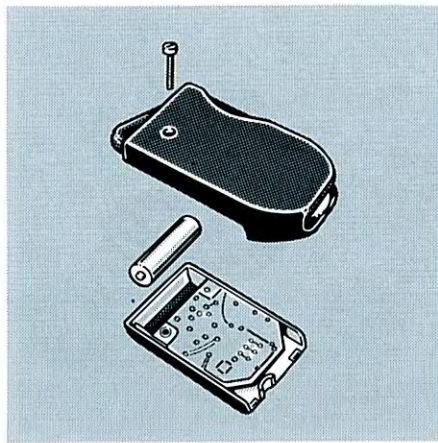

Use the "b" button to operate the remote control.

### Replacing the remote-control battery

A weak battery may be recognized by the clearly reduced action range of the remote control.

Spare batteries (Alkaline A 23, 12 volts) are available at your Official Porsche Centre, a Bosch Service or local shops.

1. Loosen the screw of the remote control casing.
2. Remove the casing's cover and replace the battery (check correct position).
3. Tighten the lid and check proper functioning.

Any disposal regulations for batteries must be observed!



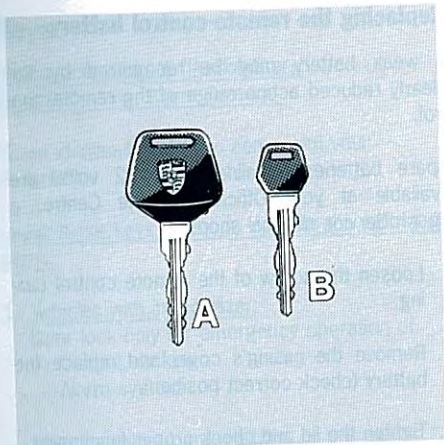

A - Key with lamp  
B - Flat key

### Vehicles without immobilizer

A lamp that will light up when the button is pressed is integrated into the grip of key "A".

You can keep the flat key "B" in your wallet or purse, for example, as an "emergency" key.

The key bit of the flat key can also be clipped to an additional grip with integrated lamp. For this purpose, remove the plastic grip of the flat key.

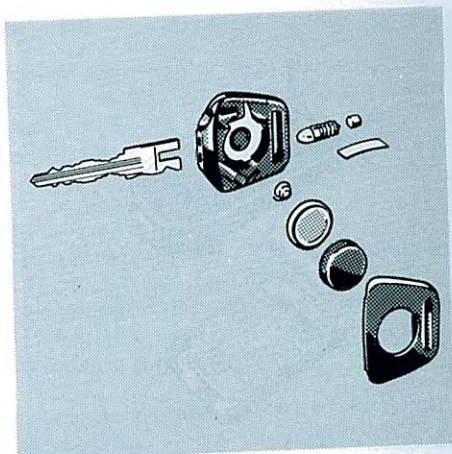

### Replacing the battery for the key light

When the beam begins to fade, fit a new battery.

1. Using your finger nail or a small screwdriver, carefully lift off the cover of the key grip.
2. Insert a new, commercially available battery (1.5 V) in the contact button.
3. Reassemble the key head as illustrated.

Any disposal regulations for batteries must be observed!



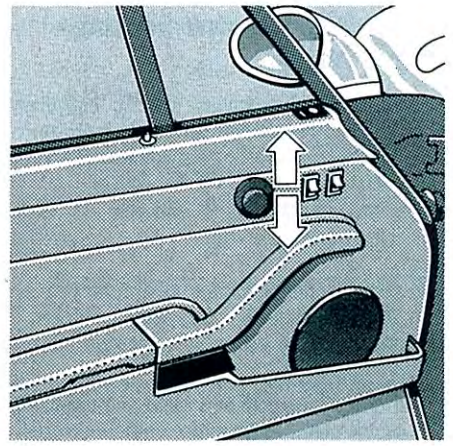
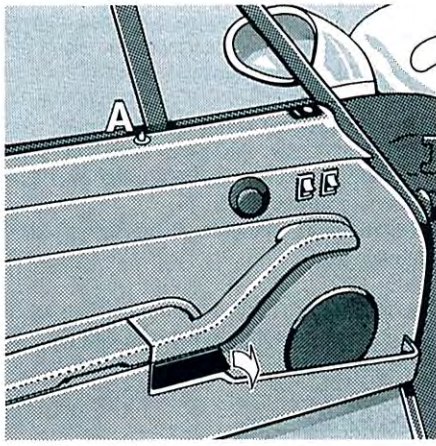
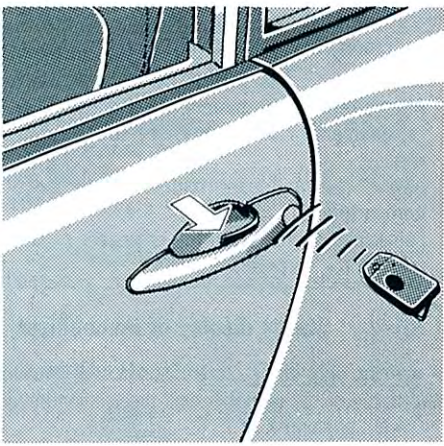

A - Light-emitting diode of alarm system

## Doors

Vehicles with immobilizer must only be locked and unlocked using the remote control.

Vehicles without immobilizer must be locked and unlocked using the key.

The unlocked doors can be opened from the outside by pulling the lever, and from inside by pulling the inner door handle.

## Power Windows

Both door windows are controlled by up/down switches in the door panels. The passenger's side window can also be operated using the front switch on the driver's side. When the doors are closed, the power windows will operate only when the ignition key is in position 1 or 2.

When a door is open, the power windows will operate even if the ignition key has been removed.

### Caution:

In view of the danger of injury when the windows are closed by occupants unfamiliar with the vehicle (children), the driver should always remove the ignition key when leaving the car even for a brief period.



## Immobilizer, Central Locking, Alarm System

Depending on the country specific equipment, your car has been fitted with an immobilizer as an additional safety feature together with the car alarm system.

While the immobilizer is activated, it is impossible to use the starter.

The remote control for the central locking system, the alarm system and the immobilizer is integrated into the grip of your car key.

The doors may only be locked and unlocked using the manual transmitter (remote control).

To avoid operating errors, the door lock cylinder is covered with a plastic cap. If necessary (emergency deactivation), you can remove the plastic cap with your fingernails.

### Functioning:

With the doors closed, pressing the remote control button will activate:

- the central locking system
- the alarm system
- the immobilizer (starter cannot be operated).

The activation is completed when the light-emitting diodes in the doors start flashing.

Operating the remote control a second time will unlock the vehicle and deactivate the alarm system and the immobilizer.

If one of the doors is not closed properly when you lock the car, the alarm horn will sound briefly. The car can only be locked after both doors have been closed.

Close the door properly and press the remote control twice.

The transmitter's action range reaches up to 5m, depending on the environment and the state of the battery.

### Malfunctions:

Frequent actuation of the transmitter outside its action range causes a premature discharge of the battery.

A weak battery may be recognized by the clearly reduced action range of the manual transmitter.

If the car cannot be locked or unlocked even when the light-emitting diode of the manual transmitter is still illuminated, operate the manual transmitter three times within 10 seconds, holding it close to the window.

In case of a failure of the manual transmitter: See "Emergency operation using the car key".

Always replace the battery in good time. (For replacement of the battery, see "Keys" chapter).

Always keep a spare battery in the glove compartment.

Familiarize yourself with the emergency operation of the immobilizer.



### Status display of immobilizer

A warning light in the clock displays the functioning status of the immobilizer if the ignition key is in switch position 1 or 2.

- Warning light is illuminated for approx. 2 sec. after the ignition has been switched on to check the light for proper functioning. Then it will go off.  
The immobilizer is deactivated.
- Warning light on  
The immobilizer is activated and must be deactivated using the remote control
- Warning light flashes after the ignition has been switched on  
Immobilizer failure  
The cause of the fault must be rectified by an Official Porsche Centre.

**Automatic self-priming of the immobilizer (alarm system switched off)**

After removing the ignition key, the immobilizer will be activated automatically after 3 minutes. When the ignition is switched on, this will be indicated by the warning light in the clock.

In this case, the immobilizer must be deactivated using the remote control before starting the engine.

**Automatic relocking**

If the car is unlocked by remote control and subsequently none of the doors are opened within a period of one minute, doors will be automatically relocked and the alarm system and immobilizer will be activated.

In this case, the remote control must be operated twice to unlock the doors.

**Display over emergency flasher**

The immobilizer is equipped to acknowledge the locking status over the direction indicator lights.

If the car has been locked by remote control, the direction indicator lights will flash twice.

During unlocking, the direction indicator lights will flash once.

**Manual transmitters (remote controls)**

A maximum of 4 manual transmitters may be allocated to your car.

Additional manual transmitters must always be tuned-in with the transmitters already belonging to the car, which will have to be reset on the occasion.

To this aim, the emergency unlocking process (items 1 – 5 on the following page) must be carried out.

Enter the code number and start resetting within one minute.

Setting of manual transmitter:

Keep button on manual transmitter pressed until the light-emitting diode of the alarm system in the door starts flashing. Setting of the transmitter is terminated.

Set one transmitter after the other. If no further manual transmitter is actuated within one minute or the ignition is switched off, the setting process will be aborted.



## Emergency operation using the car key in case of a failure of the remote control

### Note:

It is recommended to copy this page and to keep the copy together with the vehicle's documents to have it readily available in case of an emergency.

Familiarize yourself with the emergency operation procedure of the immobilizer.

The four-digit number is noted on your car key card (in a frame). This number is required to deactivate the immobilizer. Please keep the key card in a safe place (not in the car).

For emergency operation of the door locks, the plastic cap has to be removed from the door lock cylinder.

When the following times are exceeded, emergency unlocking will be aborted and the alarm will be triggered.

### Emergency locking of the doors:

Lock the car using the key.

The alarm and immobilizer are activated automatically.

### Emergency unlocking of the doors and deactivation of the immobilizer:

The four-digit code number (key card) is entered using the ignition key and switching the ignition off and on in rapid succession.

100 seconds are available for doing so.

Every single digit represents the number of off-on switch processes.

Start with the first (left) digit.

The digit "0" is entered by switching the ignition off and on 10 times.

Before continuing to enter the next digit, wait for the warning lamp to light up.

1. The door lock must be unlocked - locked - unlocked within 5 seconds.

2. Within another 10 seconds, the door must be opened and the ignition switched on.

 The warning light in the clock will come on and will go off after 15 seconds.

3. Switch the ignition off and on within 5 seconds. The warning light will come on and will start flashing after 15 seconds.

4. Entering the code number must start within 5 seconds.

5. Example: Code number 1212

1 = ignition off - on

Wait for warning light acknowledgement

2 = ignition off - on, off - on

Wait for warning light acknowledgement

1 = ignition off - on

Wait for warning light acknowledgement

2 = ignition off - on, off - on

After the code number has been entered properly, the warning light will start flashing\*.

The engine can be started after switching the ignition off one more time.

The immobilizer is deactivated, the alarm system and the central locking system are unlocked.

If the warning light does not flash after the code number has been entered, repeat steps 1 - 5.

Automatic self-priming is not deactivated by emergency operation.

\* Start setting the manual transmitters.



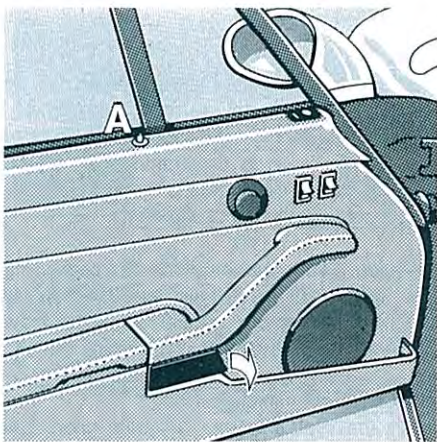

A - Light-emitting diode of alarm system

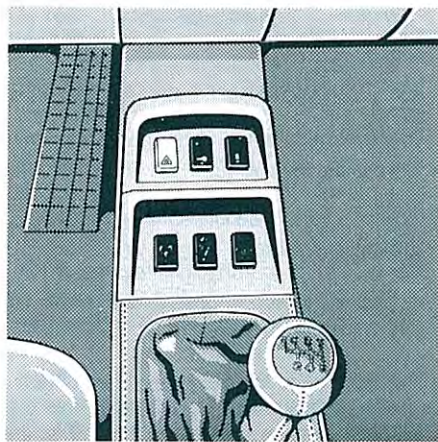

## Central Locking

Please note chapter "Immobilizer, Central Locking, Alarm System".

With the central locking system, both doors can be electrically locked or unlocked.

### Vehicles with immobilizer:

In order to lock the vehicle, both doors must be closed.

The alarm reminds you with a short signal if one of the doors is not properly shut. You cannot lock the car until both doors are fully shut.

### Vehicles without immobilizer:

In order to lock the vehicle, the driver's door must be closed. The passenger's door can be closed after activating the central locking system.



### Central locking button

By pressing the central locking button in the centre console, it is possible to lock both doors electrically. As a check, an indicator lamp in the button lights up when the doors are locked.

To unlock via the locking button, the ignition must be switched on.

The doors are opened and electrically unlocked by pulling the inner door handle.

## Emergency priming

### Vehicles with immobilizer:

A failure of the central locking system will be indicated by the acoustic alarm.

The left hand door can be locked and unlocked using the key.

To do this, remove the plastic cap from the door lock cylinder.

You cannot lock the right hand door.

The alarm system can be primed by performing three locking actions in rapid succession or by operating the remote control six times. The LED's indicate this with a double-flashing signal.

### Vehicles without immobilizer:

Should the central locking fail, both doors can be opened and closed using the key.

The alarm system can be switched on by performing the locking action three times in quick succession.

The LED's indicate this with a double-flashing signal.

Have the fault repaired at an Official Porsche Centre.



## Theft Protection, Alarm System

Please note chapter "Immobilizer, Central Locking, Alarm System".

To protect your vehicle from theft, you should always proceed as follows when leaving your vehicle:

- Close windows and sun roof
- Remove ignition key
- Engage steering lock
- Lock glove compartment
- Lock the handle for the luggage compartment (Cabriolet)
- Don't leave any valuables in the car
- Lock doors

### Alarm system

The alarm system is primed when one of the doors is locked. Light-emitting diodes in the doors start flashing to indicate that the alarm is primed.

If the LED's do not flash when the car is locked or if they change to a double-flashing signal after 10 seconds, not all of the alarm contacts have been closed.

The following components are monitored by the alarm:

- Doors (central locking)
- Front and rear lids
- Glove compartment
- Radio
- Ignition (immobilizer)

If an alarm contact is broken, the alarm will sound for approx. 30 seconds.

At the same time, the interior lights and the hazard warning lights flash for approx. 5 minutes. When the alarm is triggered, the LED's are switched to a double-flashing signal.

When a door lock is unlocked, the alarm system is unprimed and the LED's go out.

### Emergency priming

#### Vehicles with immobilizer:

A failure of the central locking system will be indicated by the acoustic alarm.

The left hand door can be locked and unlocked using the key. To do this, remove the plastic cap from the door lock cylinder.

You cannot lock the right hand door.

The alarm system can be primed by performing three locking actions in rapid succession or by operating the remote control six times. The LED's indicate this with a double-flashing signal.

#### Vehicles without immobilizer:

Should the central locking fail, both doors can be opened and closed using the key.

The alarm system can be switched on by performing the locking action three times in quick succession.

The LED's indicate this with a double-flashing signal.

Have the fault repaired at an Official Porsche Centre.

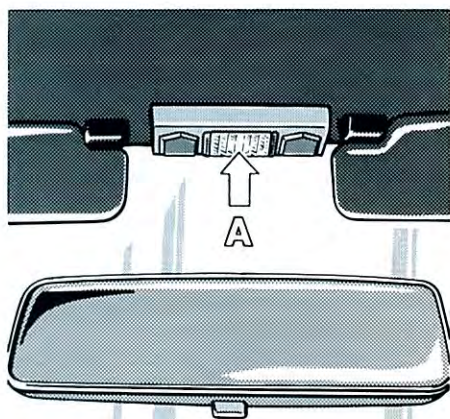

A - Multi-functional button

### Infrared Passenger - Compartment Monitoring / Interior Light

The passenger-compartment monitoring system with integrated interior light is fitted to the windshield frame between the sun visors. The diffusing lens of the interior light also serves as multi-functional switch. By pressing the button, various light settings can be chosen or the monitoring system can be switched off.

### Infrared passenger-compartment monitoring

The passenger compartment is monitored by the infrared transmitter module. In order not to limit the action range of the monitoring system, the sun visors should be in one of their end positions and the backrests of the front seats should not be folded forward.

The passenger-compartment monitoring system is activated and deactivated automatically when the vehicle is locked or unlocked.

#### Deactivating the passenger-compartment monitoring system for a locking process:

If persons or animals stay in the vehicle while it is locked, the passenger-compartment monitoring system must be switched off.

- Press multi-functional button for approx. 3 seconds.
- A flashing signal acknowledges that the monitoring system has been switched off.
- Locking of the vehicle will again be acknowledged by the flashing signal.

With the Cabriolet top or Targa roof opened, the passenger compartment monitoring system is deactivated automatically.

### Interior light (multi-functional button)

Various settings can be selected using the multi-functional button of the interior light (diffusing lens).

When the door is open, the light will be switched off automatically after 15 minutes.

#### Standard mode:

The light is switched on and off automatically by the door contact.

In addition, the light can be switched on and off in individual situations using the multi-functional button.

#### Permanent-on mode / permanent-off mode:

Press button twice - depending on the current setting, the interior light will be switched on or off.

Acknowledgement by double-flashing signal.

The light will be switched off automatically after 15 minutes. If the permanent mode is activated again, this period is extended to 30 minutes.

The permanent mode is independent of the door contact. It can be deactivated by pressing the button once.

Acknowledgement by double-flashing signal.



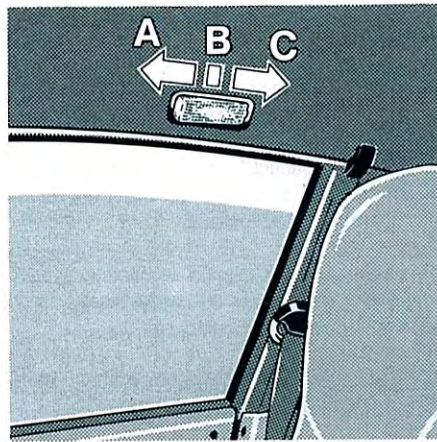

Coupé

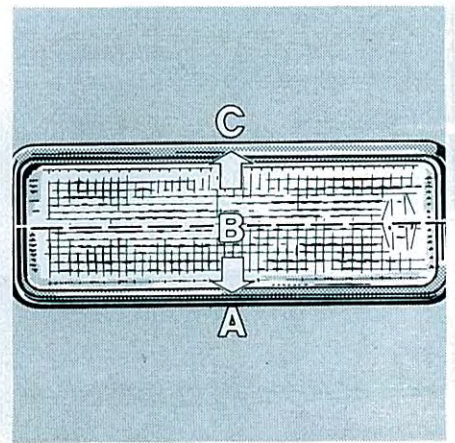

Cabriolet/Targa

### Interior Lights

When the switches are in the appropriate positions, the interior lights come on as soon as a door is unlocked or opened.

The interior lights and ignition lock lighting go out approx. 20 seconds after the doors are closed. They go out immediately if the ignition is switched on or the vehicle is locked with a key.

Make sure the interior lights are turned off when the vehicle is parked (battery run-down).

In the Coupé, two lights are located on the sides of the headliner.

By tilting the left and right ends, each light can be independently set to the following three positions:

- A – Light switched off permanently
- B – Light controlled by door contact
- C – Light switched on permanently

In the Cabriolet and Targa, the interior light is located in the windshield frame between the two sun visors.

By tilting the top and bottom of the lens, the light can be set to the following three positions:

- A – Light switched on permanently
- B – Light switched off permanently
- C – Light controlled by door contact

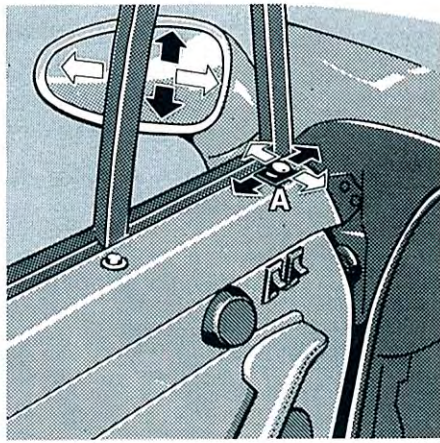
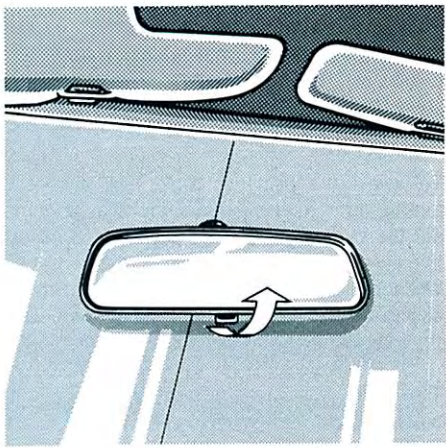

A - Rocker switch for electric door mirror

## Rear-view Mirrors

Before beginning a journey you should ensure that the rear-view mirrors are properly adjusted.

Press the lever in the bottom edge of the inside rear-view mirror to move the mirror to the anti-dazzle position.

The electrically adjustable door mirrors can be set with the switch in the driver's door.

The passenger-door outside mirror is adjusted by the same switch, if the rocker switch (A) is pressed accordingly.

When necessary, the door mirrors can also be adjusted by hand.

The convex glass of the passenger-side mirror allows a wider field of vision. When judging the distance of following traffic please note that, consequently, vehicles or objects viewed using this mirror will appear smaller and more distant than they are in reality.

When the rear window heating is switched on, the door mirrors are also electrically heated (in the Cabriolet, only the door mirrors are heated).



## Seat Adjustment

A correct seat position is essential for safe, tireless driving. The seat can be adjusted to suit individual requirements. We recommend the following procedure:

1. Move the seat backward or forward until, with the clutch fully depressed, your leg is straight but your foot is at an angle.
2. Set the desired seat height at front and rear.
3. Grip the top half of the steering wheel. Set the backrest angle so that with your arms almost fully outstretched your shoulders are still in contact with the backrest.
4. If necessary, correct the fore-and-aft adjustment once again.

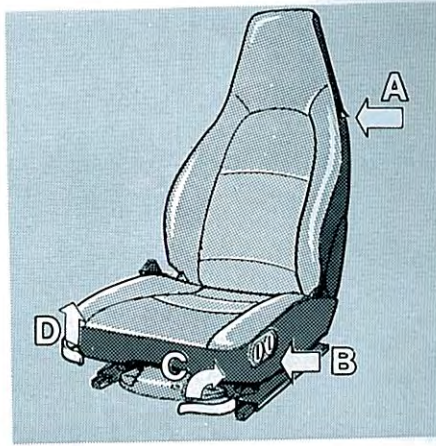

A - Backrest release  
B - Height adjustment  
C - Fore-and-aft adjustment  
D - Backrest adjustment

## Front Seats

### Seats with manual fore-and-aft and backrest adjustment

For fore-and-aft adjustment, raise the outer locking lever on the front of the seat, slide the seat to the desired position, release the lever and ensure that the seat engages securely.

Do not disengage the driver's seat catch while the car is in motion; the seat could suddenly change position, causing you to lose control of the car.

To adjust the backrest angle, pull the inside locking lever at the front of the seat upwards, set the seat to the desired position and release the lever.

When there is no load on the backrest, it will always be pushed upwards by spring force when the lever is pushed forwards.

The height of the seat at front and rear can be adjusted electrically by pressing the rocker switches.

- 3 - 4 Height adjustment front
- 7 - 8 Height adjustment rear

### Backrest Lock

The backrest is locked so that it cannot tilt forwards under heavy braking. To release, raise the knob in the side of the backrest. The backrest locks automatically when it is pushed back into position.



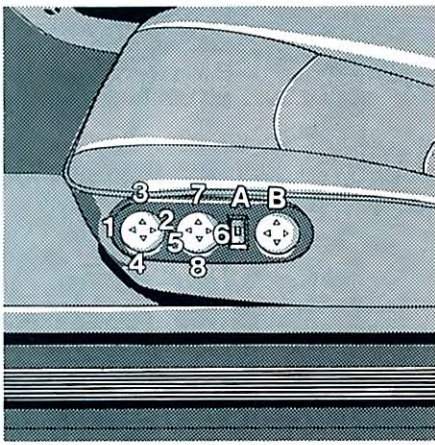

## Heated Seats

The seat heating is switched on and off at the pushbutton switch. It heats the seat cushion and the backrest.

Press upper part of switch – heating on  
Press lower part of switch – heating off

Heating temperature is controlled with the aid of the knurled knob set in the switch. The temperature is held constant until the seat heating or the ignition is switched off.

Turn knurled knob up –  
to increase temperature

Turn knurled knob down –  
to reduce temperature

## Seats with electric fore-and-aft adjustment

In vehicles with electric backrest and fore-and-aft adjustment the two front rocker switches have two additional functions.

- 1 – 2 Fore-and-aft adjustment
- 3 – 4 Height adjustment front
- 5 – 6 Backrest adjustment
- 7 – 8 Height adjustment rear
- A Seat heating
- B Lumbar support

## Lumbar Support

In order to facilitate a relaxed seated posture, the curvature of the backrest can be adjusted vertically and horizontally to any position, thereby providing individual support for pelvis and spine.

- ◀ Horizontal adjustment of backrest curvature
- ◆ Vertical adjustment of backrest curvature

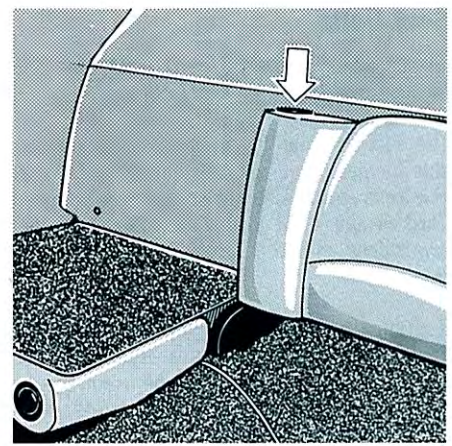

## Rear Seat Backs

The rear seat backs can be unlocked by pressing the knob and then folded over. This provides more luggage space.

To lock the backrests, fold them back until the locking knob engages.



## Seat Belts

All occupants of the car must wear seat belts for their own safety, on every journey.

The seat belts for the front seats are not suitable for persons under 150 cm (5 ft.) tall. Suitable restraint devices should therefore be used. Children should sit in the back seats for their own safety, and so that they do not distract the driver.

If children have to travel in the front passenger seat, only restraint systems specifically approved for this purpose are to be used. See the chapter entitled "Child Restraint System".

Never use a safety belt for two people at once.

Remove any loose, bulky items of clothing that prevent the belt from fitting correctly and restrict your freedom of movement.

The belt cannot be pulled out while accelerating and slowing down, when cornering and when driving uphill.

Check all belts regularly for signs of damage in the fabric, and check that the lock and attachment points function correctly.

If the belts are put under severe strain in an accident, they should be replaced for your own safety.

Make sure the belts are rolled right away when not being used, otherwise they may get dirty and damaged.



### Warning light

As a reminder when you switch on the ignition, the warning light in the clock lights up until the locking tongue on the driver's belt has been inserted into the buckle.

### Fastening the belt

Assume a comfortable sitting position. Take hold of the belt tongue and pull the belt in a slow, continuous motion across your chest and lap. Insert the belt tongue into the appropriate buckle on the inboard side of the seat, until it locks securely with an audible click.

Do not lay the belt across hard or breakable objects (spectacles, ball-point pens, pipes, etc.), since these articles may represent an additional injury hazard.

Make sure that the belts are not trapped or twisted, and that they are not rubbing on sharp edges.



The lower part of the belt should always fit snugly across the pelvis. After inserting the belt tongue, always pull the diagonal part of the belt upwards in the direction of the arrow.

Pregnant passengers should position the belt as low as possible across the pelvis. Make sure it is not pressing against the abdomen.

Pull on the diagonal section of the belt now and again during the journey to ensure that the horizontal section remains tight.

## Releasing

Press the  
Hold the  
reel.

## Child R

Use onl  
been sp  
These  
matched  
Porsche  
of the cl  
Other s  
may pos

When u  
passeng  
to deact  
This pre  
result fr

Your Off  
advise y  
for a ch  
of the p

### Releasing the belt

Press the red button marked "Press".  
Hold the belt tongue and guide it to the inertia reel.

When using child restraint systems, it is absolutely necessary to observe the legal regulations valid in your country.

Important: observe the separate installation instructions of the child's seat.

### Child Restraint System

Use only child restraint systems that have been specifically recommended by Porsche. These systems have been tested and matched to the interior conditions of your Porsche and to the respective age classes of the children.  
Other systems have not been tested and may pose an increased risk of injury.

When using child restraint systems on the passenger's seat, it is absolutely necessary to deactivate the passenger's airbag. This prevents serious risks of injury that may result from the airbag.

Your Official Porsche Centre will be glad to advise you about the installation possibility for a child restraint system with deactivation of the passenger's airbag.

#### Children up to 9 months:

Children in this age group must ride in restraint systems which are installed on the passenger's seat facing away from the direction of travel. The passenger's airbag has to be deactivated.

#### Children from 9 months to 12 years:

Children in this age group ride in restraint systems facing to the front.

These systems should be installed on the rear seats whenever possible.  
When using on the passenger's seat, it is absolutely necessary to deactivate the passenger's airbag.

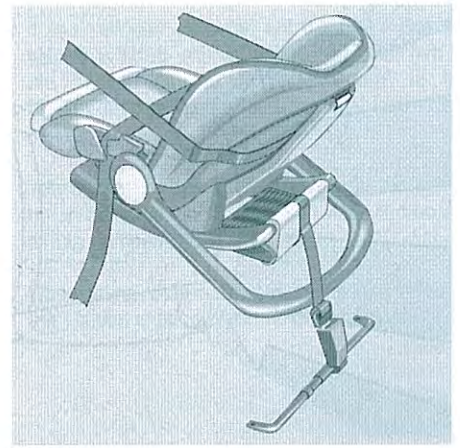

Example:  
Child restraint system for age group up to 9 months

In order to deactivate the passenger's airbag, the belt tongue of the child's seat must always be inserted in the buckle in front of the passenger's seat (figure).

When the ignition is switched on, deactivation of the airbag is indicated by the airbag warning light flashing for 10 seconds. If the light does not flash, a child restraint system must not be installed.

Have the fault remedied immediately by an Official Porsche Centre.



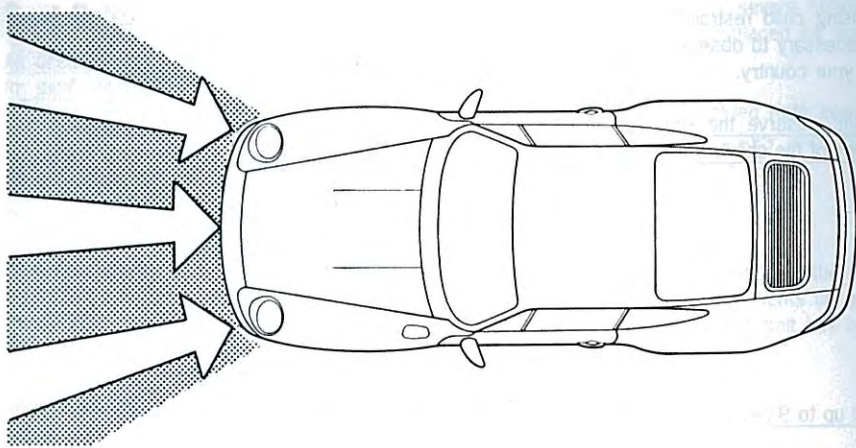

## Airbag System

Combined with the safety belts, the airbag represents a safety system which provides the driver and passenger with the highest possible degree of protection against injury in the event of an accident.

You must put on your safety belt even if your car is equipped with airbags, as the airbags only activate if the crash is above a certain force and within a certain range of angles. For activation range, see diagram.

Below the activation threshold of the airbag system and in accidents that do not lead directly to the system being activated, correctly used safety belts are a highly effective form of passenger protection.

### Function

In the event of a crash of sufficient force, a central activation device sends a signal to the ignition mechanism.

When ignited, the propellant in the airbag inflator combusts in a fraction of a second.

This combustion produces the amount of gas and the pressure required to fill the airbag.

On the driver's side, the airbag is located beneath the padded steering wheel panel, and on the passenger's side it is in the dashboard.

The airbag deflates quickly after inflation, so it does not block the driver's vision for a significant period of time. Also, the sound of detonation is drowned out by the crash itself.

The airbag protects the face and upper body, while damping the forward motion of the driver and front seat passenger.

Make sure there are no people, animals or objects between the driver or passenger and the area into which the airbag inflates.

Do not sit any closer to the airbags than necessary, otherwise they will not be able to protect you properly.

Always hold the steering wheel by the outer rim.

To avoid injury, never transport heavy objects on or in front of the front passenger seat.



## Warning light

The central activation device monitors the airbags and warning light to make sure they are ready to function.

The warning light in the clock indicates any faults that occur. The "Airbag" warning light comes on for about three seconds when you turn on the ignition.

In either of the following cases, visit an Official Porsche Centre immediately to make sure these devices are functional:

- If the airbag warning light comes on while driving or lights up again 5 seconds after the ignition has been switched on.
- If the airbag warning light does not light up when you turn on the ignition.

If the passenger airbag is deactivated by the child restraint system, the warning light will flash for 10 seconds when you turn on the ignition.

## Maintenance

To ensure that it is working properly, the airbag system should be checked after 4, 8 and 10 years of service and every two years thereafter by your Official Porsche Centre.

## Safety and disposal instructions

Once the airbag has been triggered, it should be checked or replaced immediately at an Official Porsche Centre.

No modifications should be made to the wiring or components of the airbag system. Do not attach any additional trim or stickers to the steering wheel or in the vicinity of the passenger's airbag.

Airbag components (e.g. steering wheel) may only be disassembled by an Official Porsche Centre.

Do not lay any cables for additional electrical equipment in the vicinity of the airbag cable train.

Faults should always be repaired by an Official Porsche Centre.

Non-ignited gas generators, or whole vehicles or subassemblies with airbag units, must not be disposed of as "normal" scrap or waste.

Your Official Porsche Centre will be able to give you details about disposal.

## Important:

If you sell your Porsche, tell the buyer that the vehicle is fitted with an airbag and refer him to the section entitled "Airbag System" in the Driver's Manual (Safety and Disposal Instructions).

You will find further information about the airbag on an adhesive label on the sun visor and on the airbag components.

When fitting child safety seats, please refer to the section entitled "Child Restraint System".



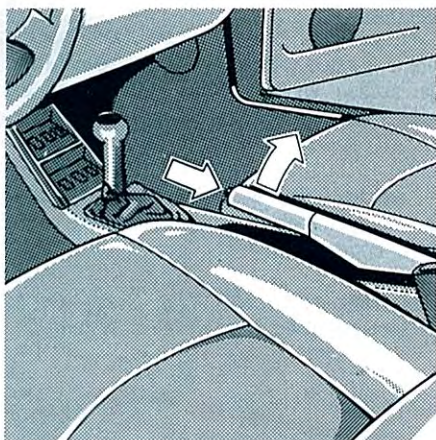

## Footbrake

Do not obstruct the brake pedal with mats or other objects.

The brake booster is only active when the engine is running. This means that a considerable amount of extra force is required for braking when the engine is switched off or if the brake booster is defective. Refer to the section entitled "Towing".

In heavy rain and when driving through water, braking may be somewhat delayed at first and require more force. For this reason, keep a greater distance from the vehicle in front of you and "dry" the brakes out by applying them periodically. When doing this, make sure you are not going to obstruct any of the traffic behind you.

During long journeys on salted roads, a coating may form on the brake discs and pads which considerably reduces the coefficient of friction and thus the braking effect.

The brake discs and brake pads should therefore be cleaned every two weeks using a powerful water jet. The cleaning provided by automatic car wash machines is not sufficient.

To prevent corrosion of the brake discs, "brake dry" the brakes before you park the car.

Change down in good time when driving downhill in order to reduce the wear on the brakes with the engine braking effect. If the engine braking effect is not sufficient on steep downhill stretches, apply the brakes at intervals. Braking continuously causes the brakes to overheat and impedes the braking effect.

### Carrera 4, Carrera 4S, Turbo:

If pressure is lost, the central warning light and brake pressure warning light in the instrument cluster will come on. Once the stored pressure has been used up, considerably more pedal pressure is required.

## Handbrake

The handbrake acts on the rear wheels via cables. Pull the lever up to apply the handbrake when parking.

To release the handbrake, pull the lever up slightly, hold down the locking button and lower the lever once the ratchet disengages.

The handbrake warning light will not go out until the handbrake is fully released.

## ABS Brake System

(Anti-lock Brake System)

ABS represents a significant improvement to active safety in your vehicle.

It prevents the wheels from locking during full brake application, on almost any road surface, until shortly before the vehicle stops.

ABS thus ensures:

### Full steering control

The vehicle remains steerable

### Good driving stability

No skidding due to locked wheels

### Optimum braking distances

Shorter stopping distances in most cases

### No wheel locking

No flat spots on the tyres

The crucial advantage of ABS is that the vehicle remains stable and manoeuvrable in hazardous situations, even if the brakes are applied with full force when cornering.

In spite of the advantages of ABS, the driver must still take the responsibility for adjusting his driving actions to road and weather conditions, and to the traffic situation.

The increased safety offered by the system should not induce you to take greater risks. The risk of causing an accident by driving fast is not reduced by ABS brakes.

### **Driving with ABS**

If the vehicle is braked close to the locking limit (full brake application), the ABS starts to operate. You will notice the control process (which is comparable to braking and releasing the wheels in very rapid succession) because the brake pedal pulsates and an audible noise is created which serves as a warning to adjust the vehicle's speed to road conditions.

### **Warning light**

The ABS warning light in the large instrument cluster lights up when you turn on the ignition so that you can check its function.

If the ABS warning light comes on when the engine is running, this indicates that ABS has deactivated due to a fault.

If this happens, the brakes will continue to work without block prevention, like in a vehicle without ABS. Adjust your driving to suit the new braking behaviour.

The ABS system should be examined immediately at an Official Porsche Centre, so as to prevent the occurrence of further faults which may have other, unforeseeable, effects.

### Note:

The control unit of the ABS brake system is adapted to the approved tyre sizes.

If other than the approved tyre sizes are used, this can lead to different wheel speeds and thus to deactivation of the ABS.



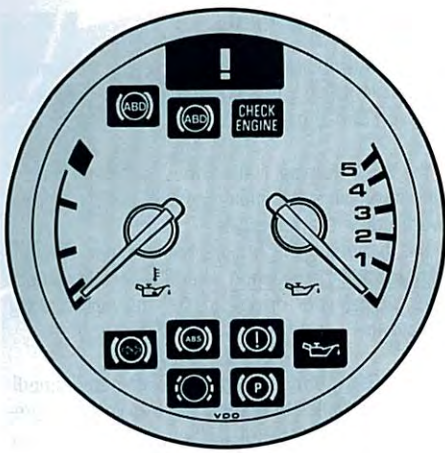

### Automatic Brake Differential (ABD)

The ABD system is a traction aid which reduces the tendency of a driven wheel to spin at speeds of up to 70 km/h (44 mph). ABD is deactivated at speeds of more than 70 km/h (44 mph).

The increased safety provided by this feature should not induce you to take greater risks. The risk of causing an accident by driving fast is not reduced by ABD.

Within the speed range up to 70 km/h (44 mph), the rotating speeds of the individual wheels are compared with each other. If a specific difference in rotating speed is reached, brake pressure is applied to the wheel which has started spinning until it starts turning at the right speed again.

When ABD intervenes, this is shown by the green indicator light in the instrument cluster.

To prevent the brakes from overheating, the control unit deactivates ABD if a particular temperature is exceeded, and keeps it deactivated until the brake system has cooled down to within the specified limit.

When this deactivation occurs, the green indicator light in the instrument cluster flashes whenever a driven wheel starts to spin on one side of the vehicle.

If a fault in the system occurs, this is shown by the red warning light in the instrument cluster.

1 - F  
2 - C  
3 - V  
4 - G  
5 - E

### Dyn

The  
are  
with  
whe

Pow  
mul  
spe  
way  
amo

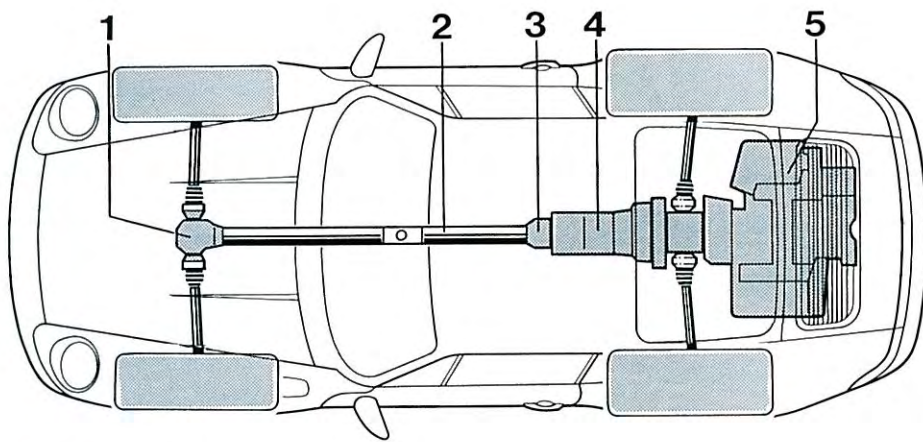

- 1 - Front axle differential
- 2 - Central shaft
- 3 - Viscous multi-disc clutch
- 4 - Gearbox
- 5 - Engine

### Dynamic Four-wheel Drive

The Carrera 4, Carrera 4S and the 911 Turbo are equipped with permanent four-wheel drive with variable power distribution on front and rear wheels.

Power distribution is executed via a viscous multi-disc clutch in function of the difference in speed between front and rear wheels. In this way, the front wheels always receive the right amount of drive torque to have optimum propul-

sion even on unfavourable road conditions.

The front wheels are driven via the viscous multi-disc clutch and a central pipe connected to the front axle differential.

Additionally, a driving dynamic system of differentials, consisting of an automatic braking aid (ABD) and a load-dependent transverse differential provide better traction and driving stability.

In spite of the advantages of a four-wheel drive, the driver must still take the responsibility for adjusting his driving actions to road and weather conditions, and to the traffic situation.

The increased safety offered by the system should not induce you to take greater risks.



### **Balancing the wheels on the vehicle**

For precision balancing, all 4 wheels must be off the ground and able to rotate freely.

### **Performance testing**

Performance test may only be carried out on 4-roller dynamometers with speed coupling. When testing on 2-roller dynamometers, the front to rear axle connection must be separated at the central shaft.

### **Brake testing**

Brake tests may only be performed on plate dynamometers or roller dynamometers.

Do not exceed the following limits when testing on roller dynamometers

Test speed 4.7 mph/7.5 km/h  
Test duration 20 sec

### **Towing**

When the car is to be towed with the front or rear axle off the ground, the wheels of the raised axle must be able to rotate freely.

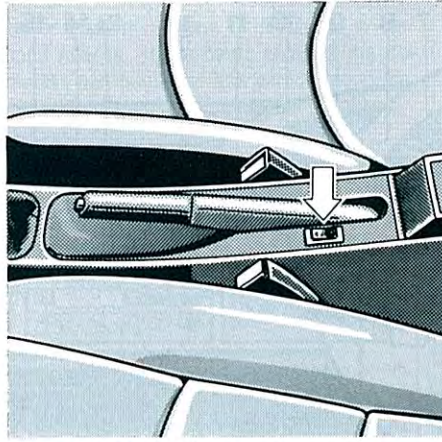
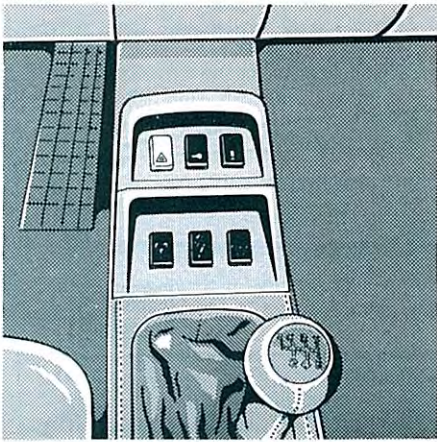

Targa: only vehicles with rear-window wiper

## Retractable Rear Spoiler

The Carrera has an electrically operated rear spoiler that extends and retracts depending on vehicle speed.

The spoiler extends to its final position at a speed of about 80 km/h (50 mph) and returns to its original position below 15 km/h (8 mph).

If the spoiler does not extend at speeds above 80 km/h (50 mph), a warning light will appear in the instrument cluster.

This means that engine cooling is no longer sufficient; monitor the oil temperature and reduce speed.

If the rear spoiler does not extend at high speeds, driving stability will be impaired by the resulting rear-axle lift.

Adjust your driving to the change in driving characteristics or extend the rear spoiler manually.

The rear spoiler can be extended and retracted manually with the ignition switched on using the rocker switch in the centre console.

In Targa vehicles with rear-window wiper, the rear spoiler switch is located next to the parking brake lever.

At a speed between 15 and 80 km/h (8 to 50 mph), a brief pressing of the rocker switch is enough to actuate the spoiler function.

At a speed under 15 km/h (8 mph), the rocker switch must be pressed down until the spoiler has reached its final position.

If the spoiler was manually extended and the speed did not exceed 80 km/h (50 mph), the spoiler can only be retracted manually.

### Caution:

When retracting or extending the rear spoiler with the vehicle at a standstill, ensure that no one is injured and that no objects are caught in the spoiler.

Have the malfunction corrected at the nearest Official Porsche Centre.



## Instruments and Controls

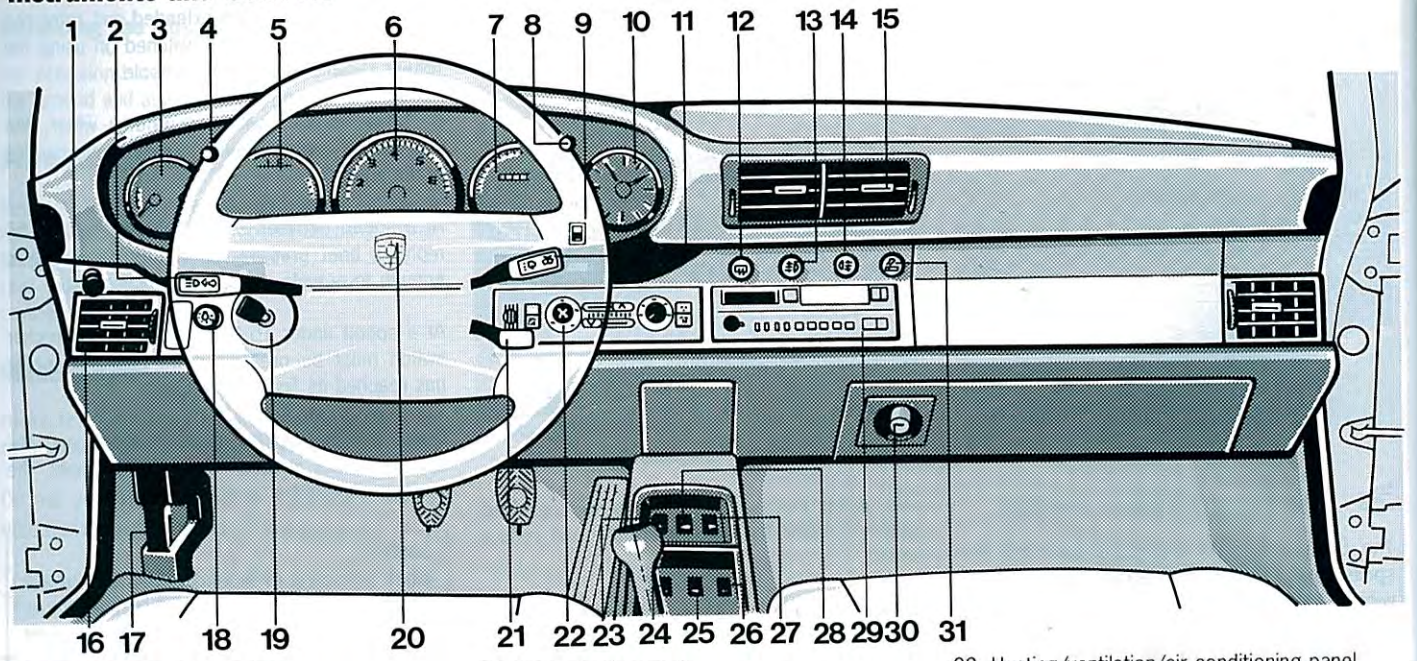

- |   |  |  |
|---|--|--|
| 1 Pull knob for fuel tank flap                                      | 11 Wiper/washer stalk                    | 22 Heating/ventilation/air conditioning panel  |
| 2 Indicator/high, dipped beam/parking light/headlight flasher stalk | 12 Rear window heating switch            | 23 Hazard warning light switch   |
| 3 Small instrument cluster  | 13 Fog light switch                      | 24, 25, 26 Rear window wiper, Rear spoiler, Sun roof switch, Cabriolet folding top, Targa roof |
| 4 Instrument illumination   | 14 Rear fog light switch                 | 27 Cancel switch   |
| 5 Large instrument cluster  | 15 Air vent                              | 28 Central locking system  |
| 6 Tachometer  | 16 Defroster vent                        | 29 Radio   |
| 7 Speedometer   | 17 Pull knob for front lid lock          | 30 Glove compartment lock  |
| 8 Intermittent wiper switch   | 18 Light switch                          | 31 Cigarette lighter   |
| 9 Clock adjustment  | 19 Ignition/starter switch/steering lock |  |
| 10 Clock  | 20 Horn                                  |  |
| 11 Wiper/washer stalk   | 21 Tempostat (automatic speed control)   |  |



## Starting and Stopping the Engine

Electronic components ensure that the engine is provided with the right mixture. Therefore, always refrain from depressing the accelerator when starting.

Please note the tips on running in.

Before starting the engine, move the gearshift lever to neutral, or the Tiptronic selector lever to position "P" or "N", and apply the handbrake.

The starter should not be operated for longer than 10 – 15 seconds. If the engine does not fire, repeat the starting procedure after a pause of approx. 10 seconds. Every time the starter motor is operated, the key must be returned to position 1 before trying again, due to the starter non-repeat unit built into the ignition lock. This device prevents inadvertent operation of the starter motor whilst the engine is running.

In cold weather, it is advisable to depress the clutch pedal fully when starting the engine, even though the transmission is in neutral. To assist the engine when starting with the engine cold, it is advisable not to stop the starting procedure as soon as the engine begins to fire.

If the battery is insufficiently charged, your Porsche can be started with jump leads or by towing.

Never start the engine or let it run in confined spaces. The exhaust contains the colourless and odourless gas carbon monoxide, which is poisonous even in small quantities.

Do not allow the engine to warm up in neutral, but drive off immediately while avoiding high rpm and full throttle until the engine has reached its normal operating temperature.

Never turn the key back to position 1, or pull the key out, whilst the vehicle is still moving.

When leaving the vehicle, even only briefly, always ensure that the ignition key is removed and the steering lock is fully engaged. This is done by rocking the steering wheel to left and right. This might also be necessary to release the lock when turning on the ignition again.

Never park your car or run the engine where there is a danger of flammable material, such as dry grass or leaves, coming into contact with the hot exhaust system.

Rear fan cut-off delay: If the ignition has been switched on for at least 30 seconds, the temperature will be monitored for 20 minutes after the ignition has been switched off.

If the temperature exceeds 75°C during this period, the rear fan will switch on and will switch off again when the temperature drops below 70°C.

The temperature will then be monitored for another 15 minutes. If the temperature limit is not exceeded during this additional period, the control unit will switch off.

Please note the information contained in the chapter entitled "Emission Control System".



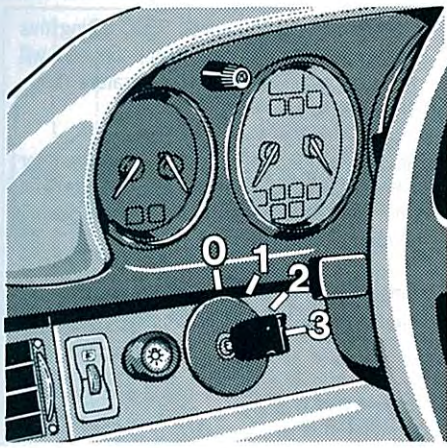

## Steering and Ignition Lock

The ignition key has 4 positions:

- 0 **The steering is locked.** All circuits connected to the ignition switch are off. This is the only position in which the ignition key can be withdrawn. Once the key is withdrawn, the steering lock can be engaged by turning the steering wheel to the right or left. Turn the steering wheel to the locking position before you switch off the engine so that you don't have to exert yourself when locking and unlocking the steering.

- 1 **Steering unlocked.** The ignition is off and the main electrical circuits (e.g. headlights, wind-screen wipers, radio) are operational.
- 2 **Ignition switched on.** All electrical circuits can now be operated. With the engine off, the warning lights come on as a check.
- 3 **By turning the key to the right, the starter motor is operated.** As soon as the engine fires, release the key. It will spring back to position 2. With the engine running, the warning lights should go out.

### Carrera:

The warning light for the rear spoiler will go out as soon as a speed of 7 km/h (4.5 mph) is reached (motion detection). While the starter motor is being operated, the circuits for items with heavy electrical consumption will be interrupted.

With the ignition key in position 1 and at low rpm with the key in position 2 (traffic jams, town driving etc.), it is advisable to switch off all items of electrical equipment which are not needed at that moment. This saves draining the battery and thus ensures a good starting performance of the engine.

## Tiptronic models

The ignition key can only be removed from the lock with the selector lever in position "P".





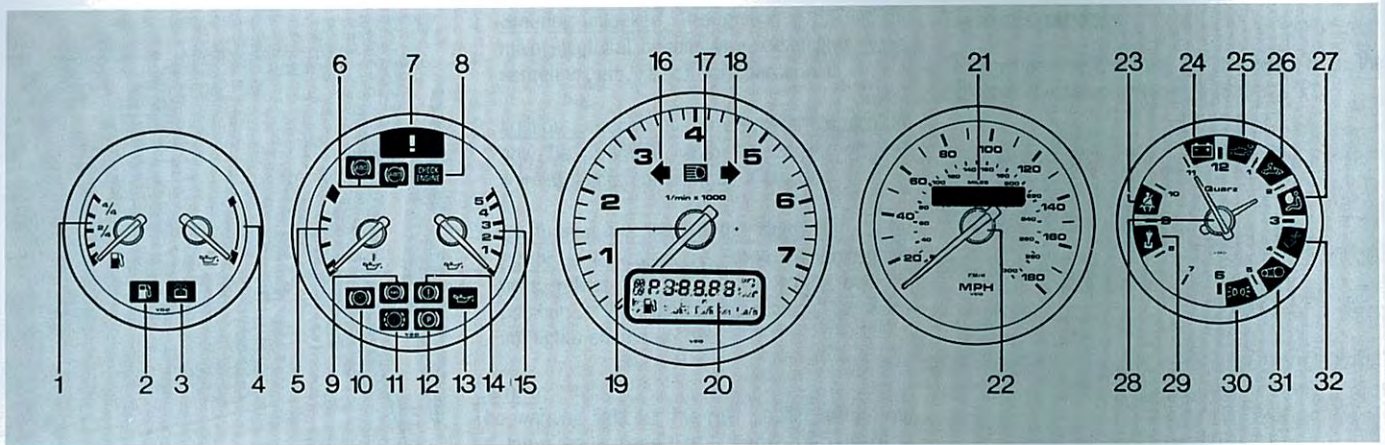

- 1 Fuel gauge
- 2 Low fuel indicator
- 3 Low washer fluid level
- 4 Engine oil level
- 5 Engine oil temperature
- 6 Automatic Brake Differential (ABD)
- 7 Central warning light
- 8 Emission control warning light
- 9 ABS warning light
- 10 Brake pressure Carrera 4, Carrera 4S, Turbo
- 11 Brake pad wear indicator

- 12 Handbrake
- 13 Oil pressure warning light
- 14 Brake pressure/brake fluid warning light
- 15 Oil pressure gauge
- 16 Left direction indicator pilot light
- 17 High beam indicator
- 18 Right direction indicator pilot light
- 19 Tachometer
- 20 On-board computer
- 21 Tripmeter
- 22 Speedometer

- 23 Seat belt warning light
- 24 Alternator warning light
- 25 Rear spoiler warning light
- 26 Cabriolet folding top
- 27 Airbag
- 28 Clock
- 29 Tiptronic
- 30 Side light indicator
- 31 Engine fan belt monitor light
- 32 Immobilizer

**Centr**  
 Warning  
 cated in  
**Func**  
 system  
 • Acti  
 • Acti  
 prior  
 • Parti  
 ing li  
 Informa  
 lights a  
 The wa  
 when t  
 once th  
 Carrera  
 The sp  
 the veh  
 (4.5 m

## Central Information System

Warning lights for the individual functions are located in the instrument dials.

### Functions of the central information system

- Activation of warning lights
- Activation of central warning light, based on priority
- Partially speed-dependent activation of warning lights and central warning light.

Information is provided by the individual warning lights and the central warning light.

The warning lights come on for a function test when the ignition is switched on, and go out once the engine has started.

#### Carrera:

The spoiler warning light does not go out until the vehicle reaches a speed of about 7 km/h (4.5 mph) (motion detection).

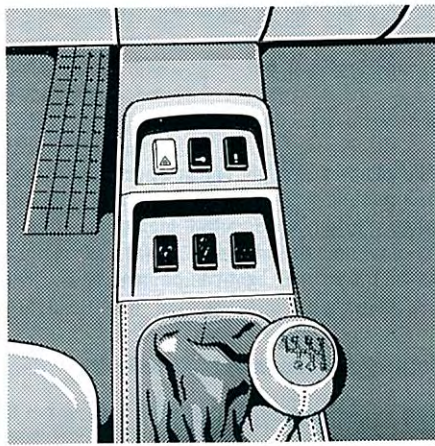

### ! Cancel button

The cancel button in the centre console is used to cancel the central warning light.

Electronic components can store warnings as they occur. These warnings can later be read out at your Official Porsche Centre.

This system can help protect you or Porsche from unjustified liabilities.



Please note the descriptions relating to the individual warning lights on the pages following.

Malfunctions that will impair **driving safety** are indicated by the individual warning light and the central warning light.

The central warning light can be cancelled.

**Warning functions:**

- Brake pressure
- Anti-lock Brake System (ABS)
- Brake fluid level
- Airbag
- Automatic Brake Differential

Malfunctions that might impair **operating safety** are indicated by the individual warning light and central warning light.

The central warning light can be cancelled.

**Warning functions:**

- Brake pad wear
- Handbrake
- Fan belt
- Oil pressure
- Fuel level
- Rear spoiler
- Tiptronic
- Cabriolet folding top

Individual warning light display.

**Warning functions:**

- Emission Control System "CHECK ENGINE"
- Washer fluid level
- Alternator warning light
- Seat belts
- Status display of immobilizer
- Side-light pilot light

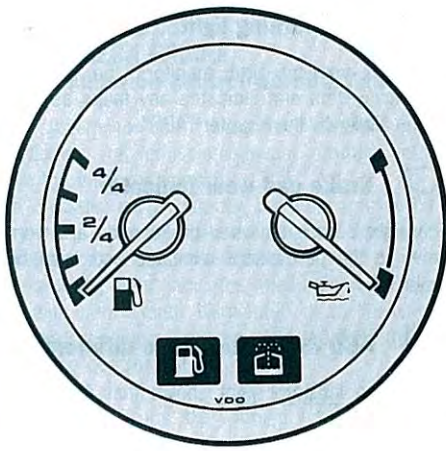

## Small Instrument Cluster

### Fuel gauge, warning light

With the ignition turned on the gauge shows the amount of fuel in the tank. If the level is too low the warning light comes on.

For fuel reserve and filling capacity, see chapter "Filling Capacities".

To prevent damage to the exhaust cleaning system:

Never keep driving until the fuel tank is completely empty.

Avoid cornering at high speed once the warning lamp has come on.

Read the section entitled "Exhaust cleaning".

If the warning light flashes on and off, there is a fault in the system. The light will then no longer indicate a lower fuel level. Consult an Official Porsche Centre to have the fault corrected.



### Washer fluid warning light

If the washer fluid light comes on, this indicates that about 2 litres of washer fluid remain in the reservoir.



### Engine oil level gauge

The oil level is indicated correctly under the following conditions:

- The car must be level
  - The engine must be warm (oil temperature indicator in area of third marking)
  - The engine must be idling.
- Wait until the needle stops moving before reading off the gauge.

The engine oil level is sufficient if the needle is horizontal.

Do not refill with oil until the needle enters the lower third of the gauge.

Never allow the needle to drop into the red zone of the dial. Under unfavourable conditions, this may result in engine damage.

It is not possible to check the oil level accurately while driving. Movements of the needle while driving are therefore of no significance.

Checking the function:

When the car is at a standstill and the engine is warm, the needle should drop when the engine accelerates.

If the oil gauge reads maximum when the ignition is switched on (engine off), there is a fault in the gauge. If this happens, check the oil level with the dipstick when the engine is warm. Have the fault repaired at the nearest Official Porsche Centre.

It is advisable to check the oil level on the gauge every time before turning off the engine (after it has reached normal operating temperature.)

Please refer to the section entitled "Checking the oil level in the oil tank, filling with oil".



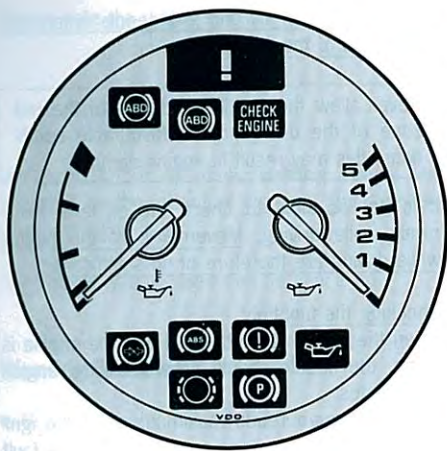

## Large Instrument Cluster

### Oil temperature gauge

The engine oil temperature affects the service life of the engine. You should therefore drive at moderate engine speeds (max. 4500 rpm) for the first five minutes after starting.

If the needle moves into the red zone, you should moderate your speed; if this does not cause the temperature to decrease, consult an Official Porsche Centre immediately.

### Oil pressure gauge, warning light

Oil pressure should be approx. 3.5 bar at 5000 rpm, with the engine at normal operating temperature. A drop in oil pressure at high temperatures is normal.

However, if oil pressure drops suddenly while you are driving, or if the red warning light comes on, stop the engine immediately.

If the oil level is normal, contact the nearest Official Porsche Centre in order to have the fault rectified.

### Central warning light

When the ignition is switched on, the central warning light in the instrument cluster and the individual warning lights come on to indicate that they are operative. In the event of a malfunction, the central warning light will come on accompanied by the relevant individual warning light.

The car should be taken immediately to the nearest Official Porsche Centre.

### ABS warning light

The ABS warning light monitors the anti-lock braking system and indicates any faults as they occur. Refer to the chapter "ABS".

### Brake pad wear indicator

This light comes on when brake pads are worn down to the permissible minimum and must be replaced.

### ABD Automatic brake differential

The green indicator light shows that ABD is in operation.

To prevent the brakes from overheating, the control unit deactivates ABD if a particular temperature is exceeded, and keeps it deactivated until the brake system has cooled down to within the specified limit. When this deactivation occurs, the green indicator light in the instrument cluster flashes whenever a driven wheel starts to spin.

The red warning light shows if there is a malfunction in the system.

Refer to chapter "Automatic Brake Differential".



### **911 Turbo: CHECK ENGINE Emission control warning light**

This system (on-board diagnosis) monitors the functioning of emission-relevant components, while the engine is running.

The system early detects malfunctions which may, for example, cause increased pollutant emission or consequential damages.

The warning light indicates malfunctions either by being permanently illuminated or by flashing. Warning messages are stored in the fault memory of the control unit.

To check the lamps, the warning light illuminates when the ignition is turned on and automatically extinguishes 1 second after the engine has been started.

A flashing warning light indicates operating conditions (e.g. misfire), that can damage parts of the emission control system.

In this case, immediately reduce the engine load by lifting your foot off the accelerator pedal. After leaving the critical range, the warning light is illuminated permanently.

To avoid consequential damages to the engine or the emission control system (e.g. the catalytic converter), you should immediately drive to the next Official Porsche Centre for fault diagnosis or repairs.

If the warning light keeps flashing even after the engine load has been reduced, immediately turn off the engine. Contact the next Official Porsche Centre to remedy the malfunction.

### **(!) Brake fluid warning light**

The brake fluid warning light comes on if the brake fluid drops below the minimum permissible level or if one of the two brake circuits has failed, in conjunction with a longer pedal travel.

If the lock warning light does not go out, you must adapt your speed to the increased braking distance, the higher pedal pressure and the changes in braking behaviour, particularly in curves. Drive carefully to the next Official Porsche Centre without delay.

### **(=) Brake pressure warning light Carrera 4, Carrera 4S, Turbo**

The brake pressure is monitored in addition to the brake fluid level.

If the brake pressure and central warning lights remain on after starting the engine, you should not drive off until the pressure necessary for the brake booster has built up, and the warning lights go out.

If the warning light starts to flash after coming on, this indicates a defective warning switch.

If the lock warning light does not go out, you must adapt your speed to the increased braking distance, the higher pedal pressure and the changes in braking behaviour. Drive carefully to the next Official Porsche Centre without delay.

### **(P) Handbrake warning light**

The handbrake warning light comes on when the handbrake is applied or not fully released.





### Tachometer

The tachometer indicates the engine speed in rpm x 1000.

The red mark on the tachometer dial has been provided as a visual reminder of the maximum permissible engine speed.

When accelerating, the engine is prevented from exceeding this maximum speed by means of a cut-off in the fuel supply. When changing down through the gears, always bear the maximum permissible down-change speeds in mind.

### ↔ Indicator pilot light

The indicator pilot light flashes at the same frequency as the direction indicators themselves.

Arrow pointing left - left hand indicator  
 Arrow pointing right - right hand indicator

If the flashing frequency of the indicator increases noticeably, check whether the indicators are working.

### ☰ High beam pilot light

The high beam pilot light comes on when the headlights are on high beam and when you flash the lights.

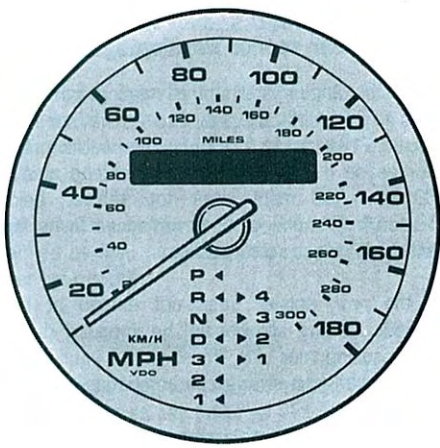

### Speedometer

The speedometer shows the vehicle's driving speed in km/h and/or mph.

The upper odometer registers the total distance driven.

The lower odometer records trip mileage, and can be reset to zero at any time by pressing the reset knob below it.

(There is no tripmeter in the speedometer in vehicles with an on-board computer.)

### Selector lever position indicator

With the ignition on or with the vehicle lighting on, the current position of the selector lever is illuminated.

The display is cancelled when the key is withdrawn or the vehicle lighting switched on.



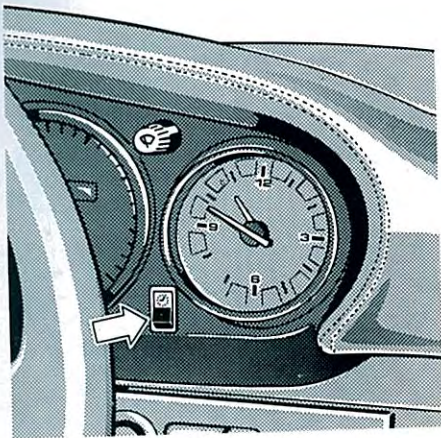

Rocker switch for setting clock time

### Clock

To set forward one minute – press briefly

To set forward rapidly – press for longer



### Seat belt warning light

The seat belt warning light remains on until the tongue of the driver's seat belt is snapped into the belt buckle.

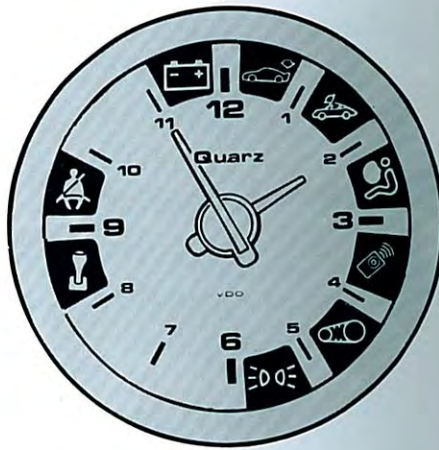

### Alternator warning light

The alternator warning light monitors the alternator and its drive belt. It comes on when the ignition is turned on, and goes out when the engine is running.

If the warning light flickers or switches on while driving, the drive belt may be loose or broken, and must be retightened or replaced. Alternatively, the problem may involve the alternator itself; in such cases it is possible to keep driving, but preferably only as far as the next Official Porsche Centre. Switch off all electrical equipment that is not absolutely essential!



### Carrera: Rear spoiler warning light

After the engine starts, the warning light does not go out until the car exceeds a speed of about 7 km/h (4.5 mph). The warning light comes on if the spoiler fails to extend at over 80 km/h (50 mph), does not retract below 15 km/h (8 mph), or does not move to its final extended or retracted position.

If the rear spoiler does not extend at high speeds, driving stability will be impaired due to the resulting rear axle lift, so adjust your driving to the change in driving characteristics.

Engine cooling will no longer be sufficient; monitor the oil temperature and reduce speed. Consult an Official Porsche Centre to have the malfunction corrected.

Should the speed-dependent control system fail, the rear spoiler can be extended manually.



The indi  
lights u  
closing  
position

Only dri  
reached  
cator lig



The airb  
tem and

If the p  
child re  
for ten

Refer to



This wa  
belt ha  
will not  
install

Stop  
the ne



### Cabriolet folding top indicator light

The indicator light for the Cabriolet folding top lights up when the folding top is opening and closing until the folding top has reached its final position.

Only drive the vehicle when the folding top has reached its final raised or lowered position (indicator light is off).



### Airbag warning light

The airbag warning light monitors the airbag system and indicates any faults as they occur.

If the passenger airbag is deactivated by the child restraint system, the warning light flashes for ten seconds when you turn on the ignition.

Refer to the chapter "Airbag System".



### Engine fan belt monitor light

This warning light indicates that the cooling fan belt has broken. If this occurs, engine cooling will not be sufficient, and a new fan belt must be installed.

Stop driving. Have the fan belt replaced at the nearest Official Porsche Centre.



### Side light pilot light

The side light pilot light comes on when the side lights are on and goes out again when the headlights are turned on.



### Tiptronic warning light

The Tiptronic warning light comes on for about a second when you turn on the ignition. If it does not go out, or if it lights up while driving, a system fault has occurred.

Refer to the section entitled "Tiptronic".



### Status display of immobilizer

A warning light in the clock displays the functioning status of the immobilizer if the ignition key is in switch position 1 or 2.

- Warning light is illuminated for approx. 2 sec. after the ignition has been switched on to check the light for proper functioning. Then it will go off.  
The immobilizer is deactivated.
- Warning light on  
The immobilizer is activated and must be deactivated using the remote control
- Warning light flashes after the ignition has been switched on  
Immobilizer failure  
The failure must be rectified by an Official Porsche Centre.



## On-board Computer



The on-board computer is operated by means of the 4-function switch on the steering column. The functions are displayed on the display in the tachometer.

All functions appear in orange letters, figures and symbols.

With the ignition switched on, the control stalk can be used to call up the on-board computer functions in turn. After the ignition is switched on, the function last displayed is automatically selected.

When the ignition is switched off, the display automatically switches to the "tripmeter" function, which is displayed for a further max. 4 minutes or which is terminated when the central locking system is operated.

## On-board computer functions

### Function displays:

#### Distance to next fuel stop



The distance to next fuel stop is continuously updated while driving based on tank level, current and average fuel consumption.

The reserve indicator light lights up independently of the range indicator. As the tank empties, the range indicator reacts more rapidly.

#### Average fuel consumption



Reset display ---

Reset = reset to zero.

The average fuel consumption displayed is based on the distance driven since the last "Reset".

#### Average speed



Reset display ---

The average fuel consumption displayed is based on the distance driven since the last "Reset".

#### Tripmeter



Reset display 0.0

#### Digital speedometer



#### Exterior temperature



Note: The exterior temperature display is not an ice warning.

Turbo: Boost pressure



If during full acceleration an engine speed of 4000 rpm is reached in the 4th or 5th gear, the boost pressure should be approx. 0.7 bar above atmospheric.

### Operation

3 – Push the control stalk forwards

This calls up the on-board computer selection mode and displays all function symbols. The function is displayed and the appropriate function symbol flashes.

If the selection mode is not exited within approx. 2 minutes by selecting a new function, the currently displayed function is automatically selected.

2 – Push the control stalk downwards

The functions can be selected by running through them one by one clockwise.

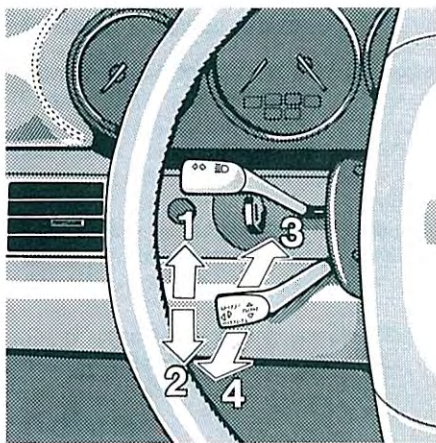

1 – Push the control stalk upwards

The functions can be selected by running through them one by one anticlockwise.

4 – Pull the stalk towards you

The selection mode is exited and the function and appropriate function symbol shine constantly. The remaining symbols go out.

Another function display can be selected by moving the control stalk to positions 1 or 2.

### Resetting the currently displayed function (Reset)

Separate resetting of the functions Average Fuel Consumption, Average Speed and Tripmeter is possible.

A Reset of a function is initiated by selecting the proper function. The control stalk must then be pulled towards the steering wheel for more than 3 seconds (stalk position 4). The corresponding display after this procedure is

Average fuel consumption	— — —
Average speed	— — —
Tripmeter	0.0

The resetting of the functions Average Fuel Consumption and Average Speed will set a starting point from which on the average value is calculated. If, for example, it is of interest to know the average speed reached over a certain distance, this function must be reset before starting out.



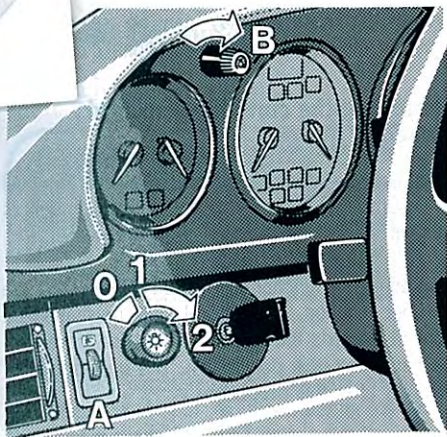

A - Headlight beam adjustment  
B - Instrument illumination

## Light Switch

- 0 - Lights switched off
- 1 - Side lights
- 2 - With the ignition on, the main headlights come on.

In switch positions 1 or 2 the following are also on: rear lights, number plate light, instrument illumination, switch symbol illumination and the blue high beam pilot light.

If the ignition key is removed and the door opened while the lights are switched on, a warning buzzer sounds.

## Instrument Illumination

The instrument illumination comes on when the vehicle lights are switched on. The brightness can be varied by turning the knurled knob "B".

## Headlight Beam Adjustment

The headlight beam adjustment system can be used to adapt the headlight range to the load condition of the vehicle. This ensures maximum road illumination without dazzling other road users.

For the basic headlight beam setting the adjuster must be set to the click-stopped "0" position.

When your Porsche is more heavily loaded, the beam setting must be corrected as shown in the table. By turning the knurled wheel "A", the beam is raised or lowered.

Check the correction by observing the dipped-beam cut-off (e.g. on the back of the vehicle in front).

### Load condition

**1** = 3 or 4 occupants with/without luggage

**0** = 1 or 2 occupants without luggage

**- 1** = 1 or 2 occupants and full complement of luggage

Vehicles with Litronic headlights do not have a headlight beam adjustment function.

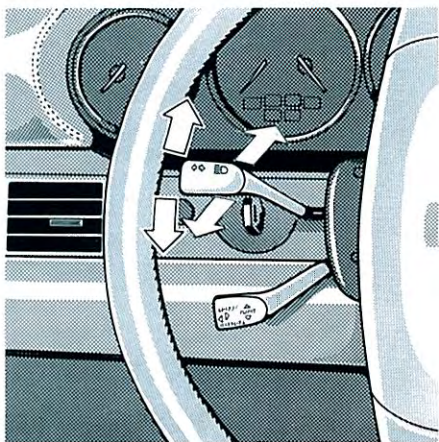

### **Indicator, High/Dipped Beam, Parking Light, Headlight Flasher Stalk**

This stalk controls the headlight flasher, high and dipped beam, the direction indicators and the parking lights.

#### **Direction indicator switch**

Move stalk upward past the point of resistance – right indicator pilot light flashes.

Move stalk downward past the point of resistance – left indicator pilot light flashes.

If the stalk is moved only as far as the point of resistance, the direction indicators operate until the stalk is released.

The direction indicators only operate with the ignition switched on.

#### **Parking light**

When the ignition key is withdrawn and the lights switched off, the parking lights light up as follows:

- if you leave the left hand indicator on, the left hand parking light remains on.
- if you leave the right hand indicator on, the right hand parking light remains on.

When you open the door, the warning buzzer sounds as a reminder.

A front side light and a rear light come on on the appropriate side.

#### **High and dipped beam, headlight flasher**

The blue pilot lamp in the tachometer lights up when high beam is on or the headlights are flashed.

When the headlights are switched on:

Dipped beam – stalk in centre position

High beam – push stalk forward

Flash headlights – pull stalk towards steering wheel



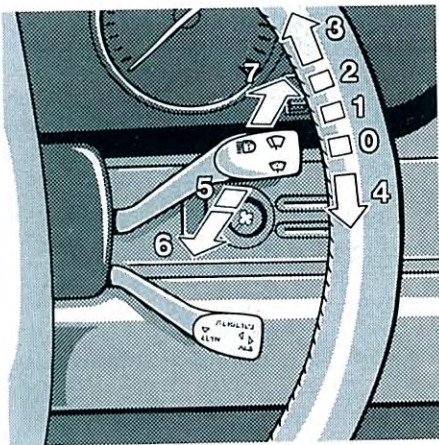

## Windscreen Wiper/Washer Stalk

The wiper/washer stalk has 7 positions:

- 0 – Wipers off
- 1 – Slow wiping speed
- 2 – Fast wiping speed
- 3 – Very fast wiping speed
- 4 – Intermittent wipe

## 5, 6 – Windscreen washer system

By pulling the stalk towards the steering wheel, the windscreen washer pump is operated in switch position "5". When the stalk is released, the wipers wipe the windscreen a few times.

In switch position "6", the windscreen washer pump and wipers operate together. Before operating the wiper system, the windscreen must be sufficiently wet to prevent the glass from being scratched. Check your wiper blades regularly and replace at least once a year.

With the ignition on, the windscreen washer nozzles are heated.

## 7 – Headlight cleaning system

With the lights on (high or -beam headlights) the system is operated by briefly pressing the wiper/washer stalk towards the instrument panel.

The washer pump supplies water under high pressure to the spray nozzles located in front of the headlights. The spray duration is limited by a relay, so if the headlights are particularly dirty, repeat the process as necessary. Stubborn dirt (e.g. dried-on insects) should be removed regularly.

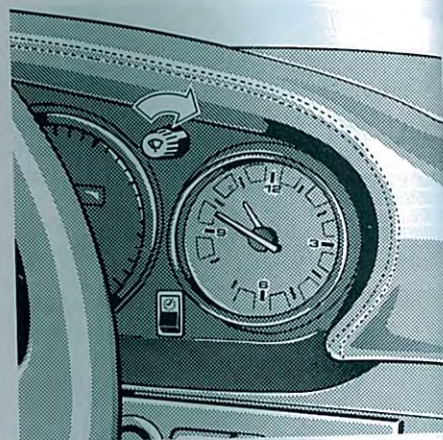

## Wipe Interval

The wipe intervals can be regulated to any setting by turning the knurled knob.

1 - Set  
2 - Rec  
3 - Car

Tem  
(Aut

The T  
within  
witho  
tive o  
celera

The c  
the s



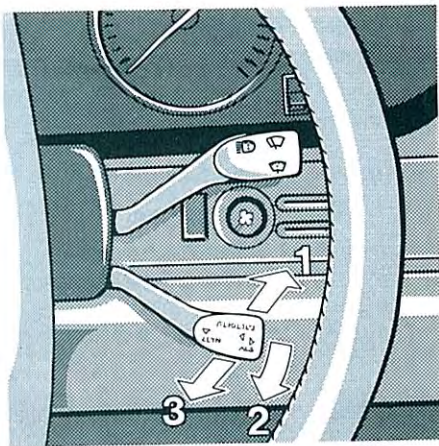

- 1 - Set/accelerate
- 2 - Recall
- 3 - Cancel

## Tempostat (Automatic Speed Control)

The Tempostat will maintain any desired speed within the range 40-250 km/h (25-156 mph) without you operating the accelerator. Irrespective of this, you can brake, change gear and accelerate as normal.

The operation of the Tempostat is controlled by the stalk behind the wiper stalk.

The vehicle's current road speed can be stored in an electronic memory by briefly pressing the control stalk forwards (1). You can then take your foot off the accelerator and this speed will be maintained.

When the vehicle is braked or stopped, the unit automatically cuts out, but the last information (speed) stored remains in the memory. This information can be recalled by pressing the stalk downwards (2). If the ignition is turned off, the electronic memory is cancelled.

If you wish to drive faster than the speed entered, you can increase speed with the accelerator or by moving the stalk forwards (1) and holding until the desired speed is attained. The speed driven when you release the control stalk is then maintained automatically. If you accelerate from the programmed speed using the accelerator pedal (e.g. when overtaking), the programmed speed will automatically be resumed as soon as you remove your foot from the accelerator.

If the programmed speed is too high, briefly pull the control stalk towards the steering wheel (3) or brake; this interrupts the Tempostat control.

Once the required lower speed is attained, tap the control lever forwards (1). The new speed is stored in the memory and maintained automatically.

## Note

When you depress the clutch, the speed control is interrupted, but resumes again when the clutch is released.

To avoid accidentally overrevving the engine, do not move the gearshift lever into neutral at road speeds above 40 km/h (25 mph) while the Tempostat is engaged.

On steep up or downhill inclines it is possible that the vehicle will not maintain the selected speed in a higher gear; in this case you should change down to avoid overloading the engine (uphill) or to achieve sufficient engine braking (downhill).

For safety reasons the Tempostat should not be used in heavy traffic or when road conditions are unsuitable (e.g. winding or slippery roads).



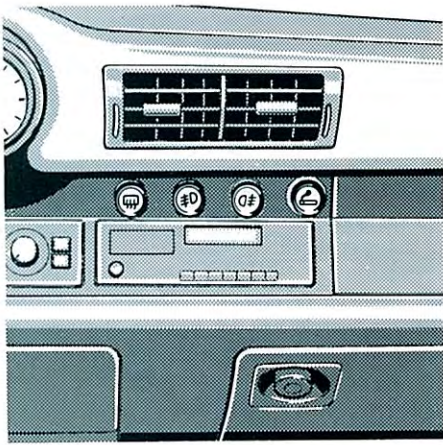

### **Heated Rear Window**

The rear window heating is operated by pulling the switch. An indicator light in the switch burns while the rear window is being heated. The heating switches off after approx. 12 minutes. The heating may be switched on again or switched off prematurely by pulling the switch anew.

When the rear window heating is on, the outside mirrors are also heated.

### **Heated Outside Mirror Cabriolet**

The outside mirrors are heated via the push-pull switch.

The indicator light in the switch stays on while the heating is on.

### **Fog Lights, Rear Fog Lights**

The fog lights and the rear fog lights can be switched on in addition to the headlights and rear lights. With the fog lights or rear fog lights on a pilot lamp in the rocker switch lights up. In vehicles with fog lights and rear fog lights the rear fog lights can only be switched on if the fog lights are on.

**Caution:**  
Comply with local traffic regulations regarding these fog lights.

### **Cigarette Lighter**

By pushing in the button the filament is caused to heat up. The cigarette lighter will pop out when it has reached the required temperature.

The cigarette lighter works even when the key is not in the ignition.

The socket of the cigarette lighter may be used for small electrical appliances, such as electric light or a compressor. The maximum rating of such equipment should not exceed approx. 120 W/12 V.

With the engine not running, electrical appliances must be used no longer than 5 minutes (battery run-down).

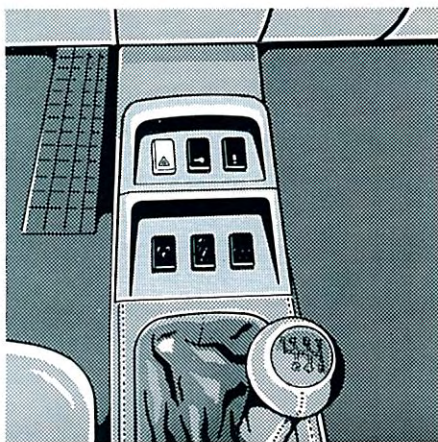

### **Rear Window Wiper**

To avoid scratching the rear window, check that it is wet enough before operating the rear screen window switch.

The system switches off automatically after a few wipes.

### **Hazard Warning Light Switch**

The switch on the central console activates the hazard warning lights whether the ignition is switched on or not.

The hazard lights and the pilot light in the switch all flash at the same frequency.





### Ashtray

To open, briefly press the ashtray cover. It will then open automatically.

To empty, open the ashtray and simply pull out the insert.

### Glove Compartment

To open the glove compartment, turn the locking button.

To protect the contents from unauthorized access, the compartment can be locked with the ignition key.

Make sure the glove compartment is closed when the vehicle is parked (battery run-down).

### Storage Compartment in Door

There is an storage compartment beneath the armrest.

Fold up the armrest to open the compartment.

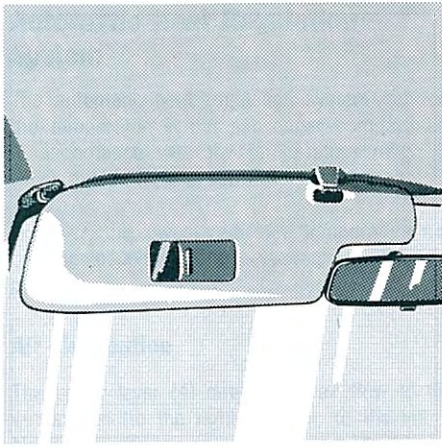

### **Sun Visors**

To avoid dazzling by direct light, the sun visors can be pivoted downwards.

In the Coupé the sun visors can be removed from their mountings beside the interior mirror and pivoted round to the side windows.

### **Make-up mirror**

The make-up mirror on the back of the visor is fitted with a protective sliding shutter.





Automatic heat regulation system

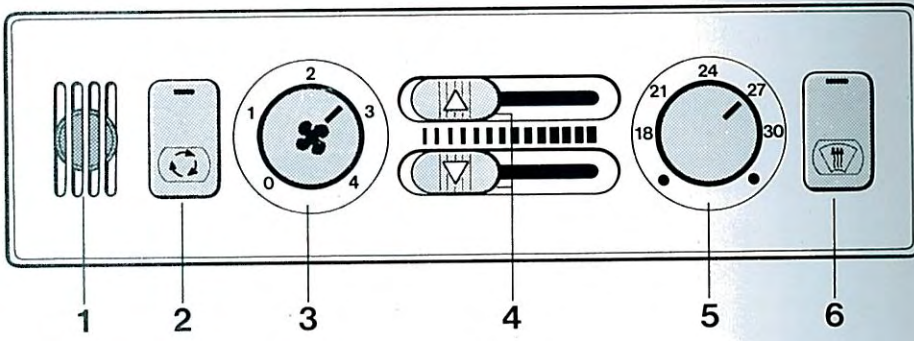

Automatically controlled air conditioning

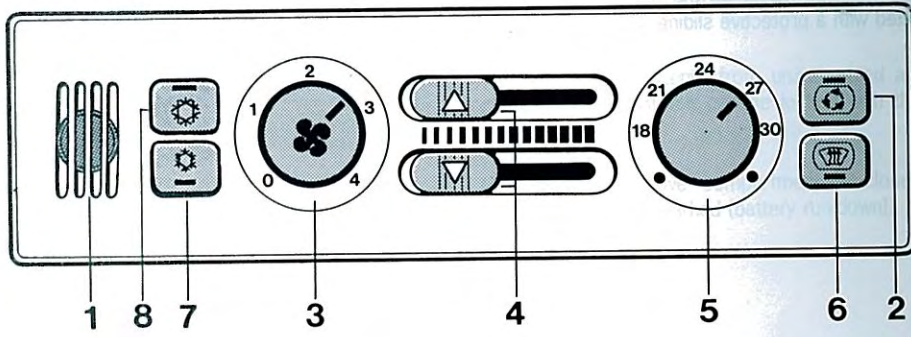

- 1 Interior temperature sensor
- 2 Air recirculating air switch
- 3 Blower control switch
- 4 Lever for air distribution
- 5 Temperature slide
- 6 Defroster switch
- 7 Air conditioning switch AC
- 8 Air conditioning switch AC MAX

## Automatic Heat Regulation System

The automatic heat regulation system controls the temperature in the passenger compartment in accordance with the temperature range to which the knob (5) is set.

However, the lowest regulated temperature can only correspond to the prevailing ambient temperature.

### Air distribution

The upper lever (4) directs the air flow to the windscreen (to the right = open, to the left = closed).

The lower lever (4) directs the air flow into the footwells (to the right = open, to the left = closed).

The centre and side vents can be opened and closed with the knurled wheels beside each vent.

Knurled wheel up – vent closed.

Knurled wheel down – vent open.

The vanes can be swivelled to deflect air in the desired direction.

#### Note:

To ensure proper air intake, the fresh air inlet on the front hood must be kept free of snow and ice in the winter.

### 3 – Blower control switch

The air volume can be regulated by turning the blower control switch from setting 0 to 4.

To provide air circulation even when your Porsche is standing still or at low speeds, the blower fan runs at low speed even when the switch is in position 0.

### 6 – Defroster switch

To defog the windows as quickly as possible, press the defroster switch (indicator light comes on).

The centre and footwell vents will now close automatically after a short delay, regardless of the positions of the upper and lower slide levers. All of the air flow will then be directed to the windscreen and the side windows. The automatic heating system will also switch to maximum fan speed (setting 4), and set itself to an interior temperature of at least 24°C. This prevents overheating of the passenger compartment.

In vehicles fitted with air conditioning the compressor is automatically switched on to dry the air when the temperature is above approx. 0°C. The centre vents close automatically.

### 2 – Recirculating air switch

By pressing the air recirculating switch you can prevent unpleasant-smelling outside air (e.g. exhaust fumes from vehicles in front) from entering the vehicle. The fresh air supply is cut off and only the air inside the vehicle is circulated. Recirculating air mode may only be used for a brief period of time, since otherwise the windows will mist up.

The air recirculating function is deactivated when the defroster switch is pressed.



## Automatically Controlled Air Conditioning

The automatic system controls the passenger compartment temperature in accordance with the range set with the temperature regulator (5).

The air conditioning only operates when the engine is running, the blower control is switched on and outside temperatures exceed approx. -1°C. After starting the engine, the AC compressor switches on at outside temperatures below approx. + 11°C with a delay of approx. 30 seconds and at temperatures above + 11°C after approx. 10 seconds.

The cooling efficiency is dependent on engine speed. If more cooling is required it is necessary – especially in city driving or stop/go conditions – to increase engine rpm.

If outside temperatures are below approx. - 1°C and the air conditioning is running, it will shut off and turn on again once temperatures reach approx. + 3°C.

### Air distribution

The air flow can be adjusted by opening and closing the centre and side vents.

The upper slide lever (4) is used to control the air flow towards the windscreen (lever to the right = open, lever to the left = closed).

The lower slide lever (4) is used to control the air flow towards the footwells (lever to the right = open, lever to the left = closed).

The air conditioner can be switched on with the air distribution levers at any setting, by pressing the AC button or the MAX AC button (indicator lamp in switch comes on).

### 7 - AC Switch

If the AC button is pressed, refrigerated air is channelled to all outlet vents. The air flow can be regulated individually by means of the blower control switch (3).

### 8 - MAX AC Switch

If the MAX AC switch is pressed, the flaps to the windscreen and footwells are automatically closed, the temperature control (5) is set to maximum refrigeration and the blower set to stage 4.

The refrigerated air comes out via the centre and side vents only.

If the vehicle has been standing for a long time in direct sunlight, it is advisable to turn on the air conditioning with the side windows open, to provide thorough ventilation .

In damp weather, the air conditioning compressor can be switched on in order to dehumid-

ify the incoming air. This prevents the windows from fogging up.

#### Important notes:

The air conditioner must be operated for a short period at least once a month to ensure that the seals and bearings of the compressor are lubricated.

To do so, set the temperature selector switch to maximum cooling temperature (all the way to the left) and open the centre vent.

Should the air conditioner become defective, e.g. if there is no cold air despite the system being switched on, switch the air conditioner off and proceed immediately to an Official Porsche Centre.

### Particle Filter

The particle filter ensures that cleaner and virtually pollen-free air enters the passenger compartment.

If air throughput is reduced, the reason for this may be that the filter is soiled.

Ask your Official Porsche Centre to replace the filter.

The filter is changed regularly as part of the routine maintenance service.

## Manual Transmission, Clutch

The fully synchromesh gearbox permits rapid and precise shifting of gears. But be sure when changing gears that the clutch pedal is fully depressed to the floor, and that the gear lever is completely engaged. The lever positions are as illustrated in the diagram.

Be sure that the pedal travel is not obstructed by floor mats.

Reverse should only be selected after the vehicle has come to a complete standstill.

Both reversing lights come on when the transmission is put into Reverse with the ignition on.

The maximum rpm figures specified below must never be exceeded when shifting down, as otherwise the engine speed would be too high.

### 911 Turbo:

If the vehicle has been parked for a longer period of time, the pressure in the pressure reservoir of the hydraulic clutch operation system may decrease. In this case, no hydraulic support is available for clutch operation. If this happens, fully depress the clutch pedal, shift into neutral and start the engine. While the engine is running, the pressure is rebuilt.

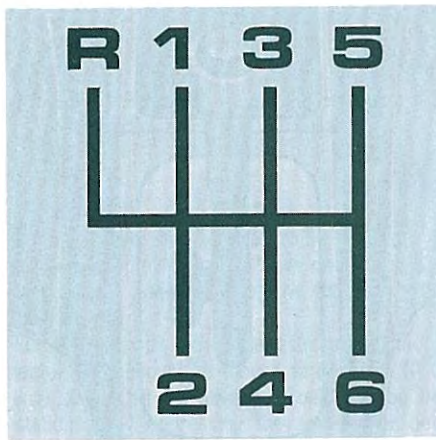

### Carrera

6th - 5th gear.....	5600 rpm
5th - 4th gear.....	5500 rpm
4th - 3rd gear .....	5300 rpm
3rd - 2nd gear.....	4500 rpm
2nd - 1st gear.....	3500 rpm

### Turbo

6th - 5th gear.....	5100 rpm
5th - 4th gear.....	5300 rpm
4th - 3rd gear .....	5200 rpm
3rd - 2nd gear.....	4700 rpm
2nd - 1st gear.....	3700 rpm



## Tiptronic S

Porsche Tiptronic is a four-speed transmission system which enables the gear to be changed quickly without interrupting the traction when accelerating.

Tiptronic has a gear selection system with an "automatic" and a "manual" selector gate.

### Left gate:

Automatic selector positions

### Right gate:

Gear change by touching selector lever or the toggle switches in the upper steering wheel spokes.

The locking button on the selector lever knob prevents accidental gear changes. This locking button has to be pressed in the automatic selection gate when switching to position "P", "R" or when changing down.

Gear changes which would exceed the upper or lower rpm limit are not executed by the control unit.

Before you leave the vehicle the parking brake has to be engaged and the selector lever moved to position "P".

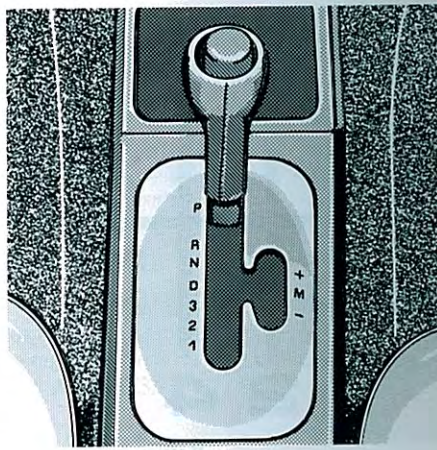

### Ignition lock positions

- 0 – selector lever is blocked
- 1 – selector lever can be moved
- 2 – selector lever can be moved from position "P" and "N" only when brake pedal is pressed

The ignition key can only be removed from the lock with the selector lever in position "P".

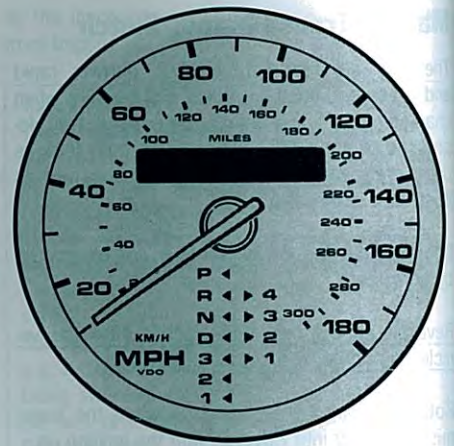

### Selector lever position indicator

The position of the selector lever is indicated on the speedometer.

The display is extinguished when the key is removed from the lock or the vehicle lighting is turned off.

During driving, the currently engaged gear is always displayed in the speedometer.



### Starting the engine/moving off

For safety reasons the engine can only be started in selector positions "P" or "N".

To move off depress the service brake pedal and select the required speed. A speed should only be selected while the engine is idling. Do not release the service brake pedal until you are ready to move off. Once a speed is selected power will always be transmitted from the engine to the road wheels and the vehicle will move at crawl speed.

When you have selected a speed, do not push down on the accelerator until power is being transmitted.

If, during cruising, the lever is accidentally moved to "N", the Tempostat automatically switches off. The Tempostat is automatically switched on again when a selector lever position is again engaged.

Driving off is possible in both speed selection gates.

During driving, the driver has the option of changing from one speed selection gate to the other via selector position "D".

Tiptronic comprises a slip monitoring circuit. As soon as the permissible speed difference between the front and rear axles is exceeded the transmission changes up to the next speed.

This increases the stability of the vehicle on slippery road surfaces.

Selector positions "R" or "P" must not be selected while the vehicle is moving or coasting to a stop.

### Stopping

During a short stop, e.g. at traffic lights, the selector lever may remain in drive position and the vehicle held stationary using the service brake.

For longer stops with the engine running the selector lever should be moved to position "N" (idling). On a hill the vehicle should not be held stationary by depressing the accelerator pedal but rather by either depressing the service brake pedal or applying the parking brake.

### Parking

When parking or manoeuvring the vehicle in a confined space the vehicle speed should be controlled using the service brake. In this situation the accelerator pedal should be used with caution!

### Automatic Gear Selection Gate

The gear-change characteristics are influenced by the accelerator pedal position, vehicle road speed, engine speed as well as longitudinal and transverse acceleration values and the topographical profile.

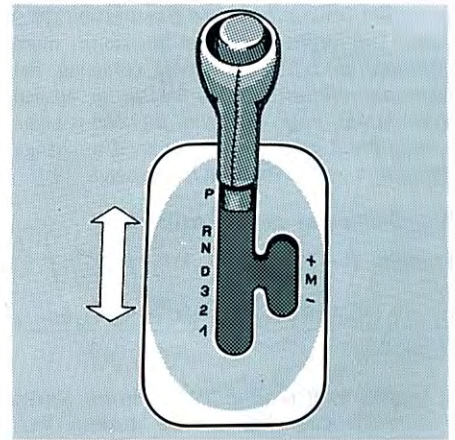

There are five different gear-changing maps available, ranging from "economy" to "sport". The speed-changing points can shift to higher or lower engine speeds, depending on the way the vehicle is driven.

Changing up before bends in the road is prevented by quick throttle reduction.

Depending on the lateral acceleration, the gears do not change up in curves until the engine speed limit has been reached.



During the braking phase, the transmission shifts down. The engine braking is thus much more effectively used. For subsequent cornering, the right gear is engaged when pressure is applied to the brakes before the bend, the bend is taken in the correct gear. You do not need to change down when accelerating out of the bend.

### Speed Selector Lever Positions

#### Position P – Parking

Do not select this position unless the vehicle is stationary.

In selector lever position "P" the driving wheels are mechanically locked. The parking lock should only be engaged after the handbrake has been applied and disengaged before the handbrake has been released.

#### Position R – Reverse speed

Position "R" must not be selected unless the vehicle is stationary and the handbrake or service brake applied.

#### Position N – Neutral

Position "N" corresponds to the neutral position of a manual transmission and must be selected when the vehicle is to be towed.

The speed ranges may only be selected while the engine is idling.

Use selector position "N" while driving only if the vehicle is in danger of skidding on a slippery road.

#### Position D

This position is intended for normal driving. All forward gears are automatically selected depending on road speed and accelerator pedal position.

In selector lever position "D" the vehicle will move off in second gear if the accelerator pedal is only slightly depressed. With more throttle the vehicle will select first gear for moving off.

#### Position 3

The vehicle drives off in 1st gear.

This selector lever position is recommended for slight gradients. This driving mode results in an improved utilisation of engine power output and also improved engine braking. The transmission automatically changes upwards through the speeds to third speed.

#### Position 2

The vehicle drives off in 1st gear.

This position should be selected for extremely steep gradients. Since the top speed selected by the transmission is second speed, engine braking is improved.

During vehicle operation in this selector position the transmission may change between first and second speed, depending on engine speed and accelerator pedal position.

On snow- or ice-covered roads position 2 is recommended for longer, steep gradients.

#### Position 1

This position should be selected for low road speeds or extreme gradients.

The first speed is maintained when the engine is under load or in overrun mode.

#### Changing-down speeds

If a lower speed range position is selected at too high an engine speed, downshifting does not take place until the engine speed has dropped to within the following rpm limits:

From D to 3 .....	4400 rpm or 174 km/h
.....	(109 mph)
From 3 to 2 .....	3800 rpm or 112 km/h
.....	(70 mph)
From 2 to 1 .....	2800 rpm or 54 km/h
.....	(34 mph)



### Temporary change-down

By quickly depressing the accelerator pedal (from about 54 km/h / 34 mph upwards) the transmission will change to the most sporty speed-changing map, i.e. to the maximum number of speed-changing points. Accordingly, the transmission changes down immediately by one or two gears.

#### Deactivating the function:

Release the accelerator pedal decisively (by about 25%).

### Kickdown

For optimum acceleration e.g. when overtaking, the accelerator pedal must be depressed beyond the full throttle (kickdown) point. Depending on the speed selector lever position and road speed, the transmission will change down to the lowest possible transmission speed. Selection of the next speed up will only take place at higher engine speeds.

The engine speeds necessary for speed changes during kickdown will remain active until the accelerator pedal depression is reduced to 50 % of throttle position.

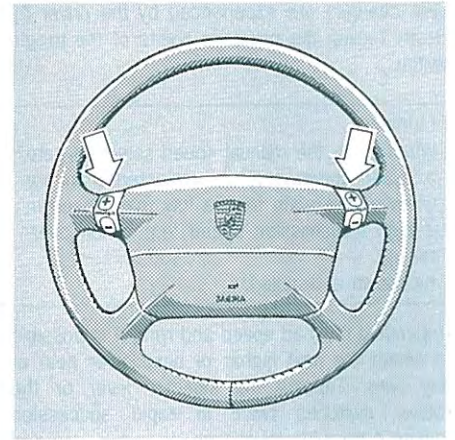
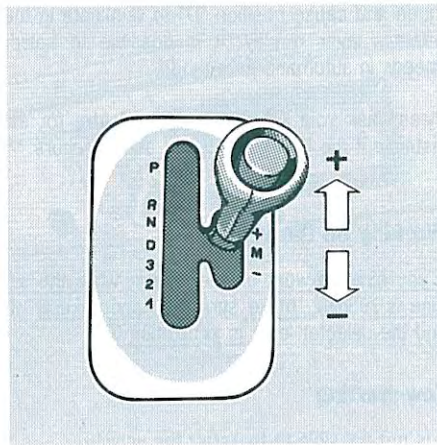

### Manual Gear Selection Gate

The manual gear selection gate allows shifting into the four forward speeds with the selector lever or the toggle switches in the steering wheel.

The manual speed selection gate can only be accessed via speed selector position "D".

The currently selected speed is maintained when changing from "D" to "M".

When changing from "M" to "D", the speed change map corresponding to the current driving style is selected, and the appropriate gear chosen.

### Changing gears from the steering wheel

Two toggle switches in the upper steering wheel spokes allow comfortable gear changing without taking the hands off the wheel.

The toggle switches are only activated when the selector lever is in the manual gate.

(+) Upshifting by pressing the upper part of the toggle switch.

(-) Downshifting by pressing the lower part of the toggle switch.



Gear changes are experienced by the driver by clearly feeling the pressure points of the toggle switch.

**Caution:**

When using the manual speed selection gate a lower speed must be selected manually when accelerating from a low road speed in a high transmission speed (e.g. when overtaking).  
Kickdown is disabled.

Depending on road speed and rpm, it is possible to select the next higher or next lower gear at any time. Tapping the selector lever or the rocker switches twice in rapid succession makes it possible to change down two gears in one go.

As soon as the engine speed limit is reached the transmission will automatically change up without interruption of traction and will change down automatically shortly before the engine idling speed is reached.

When parking the vehicle the speed selection lever should be moved to the parking position via position "D".

On snow- or ice-covered roads speeds 1 or 2 are recommended for longer, steep gradients.

If the manual selection mode should fail, the control electronics switch to automatic selection

mode and cause position "D" to illuminate in the selector lever display. It is possible to select speeds in automatic gate mode.

Please ask your Official Porsche Centre for assistance if the failure described above occurs.

### Working on the vehicle

If you have to work on the vehicle while the engine is running, make sure the handbrake is on and the selector lever is in position "P".

### Tow-starting

It is not possible to tow-start the vehicle.

### Towing

Adequate lubrication of the transmission is not ensured when the engine is not running. For this reason the following points should be noted:

1. Move speed selector lever to position "N".
2. Do not tow the vehicle at speeds higher than 50 km/h (30 mph).
3. Do not tow the vehicle over a distance of more than 50 km (30 miles).
4. For larger towing distances the rear of the vehicle should be jacked up or the vehicle transported on a recovery trailer or truck.



### Warning light, limited driving program

The warning light inside the clock comes on for about a second when you turn on the ignition. If the warning light does not go out or comes on during driving, a system fault has occurred. The automatic transmission now selects 4th speed irrespective of the speed selector position.

If the vehicle is re-started in selector positions "P" or "N" after the engine had been switched off, only the emergency speed (3rd speed) will be active in selector positions "D", 3, 2 or 1.

**Caution:**

Reverse speed lock monitoring is disabled. Do not select position "R" while driving.

Please adjust your driving to the changed driving conditions and seek the assistance of an Official Porsche Centre.



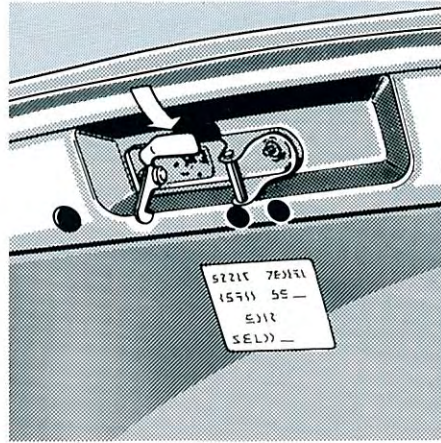
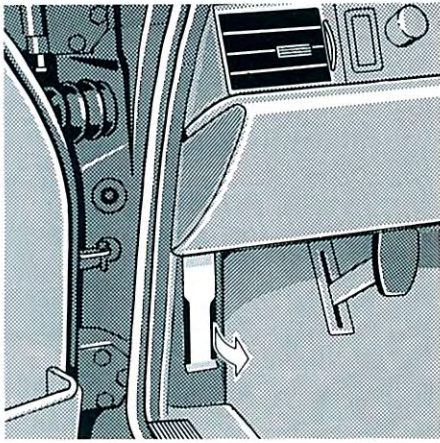

## Front Lid

### Unlocking front lid

Pull the release lever on the left underneath the instrument panel.

The lever is lockable on the Cabriolet.

### Opening the lid

Lift the front of the lid slightly, and release the safety catch by pushing the lever upwards.

Make sure that the windscreen wipers are not tilted forward.

A light in the lid comes on when the lid is open.

### Closing the lid

Lower the lid and press down on the lock until it clicks shut.

#### Note:

When closing the lid, press down on the outside edges until the lock engages; do not press on the middle of the lid.



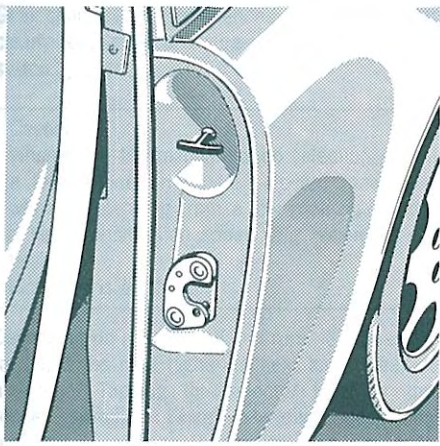

## Rear Lid (Engine Compartment)

Before working on the engine, make sure that it is turned off and cool. If you must work on the engine while it is running, be careful to ensure that items of clothing (ties, sleeves etc.), jewelry or long hair cannot get caught in the V-belts or fan.

The release handle for the engine compartment lid is recessed in the left door pillar.

Pull the handle to release the engine lid. You can then open it.

### Carrera:

The engine compartment light is always switched on when the lid is open, regardless of the vehicle light setting.

### Note:

When closing the rear lid, press down on the outside edges until the lock engages; do not press on the middle of the lid.



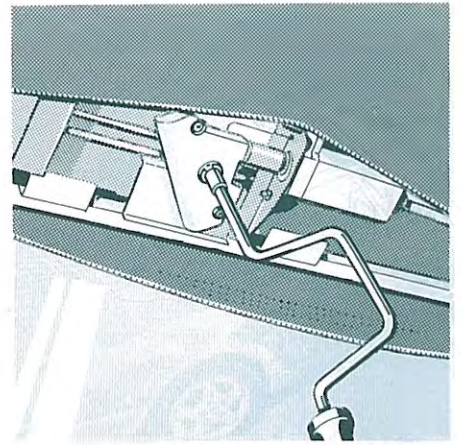
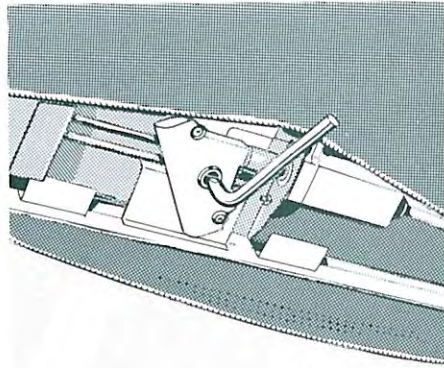
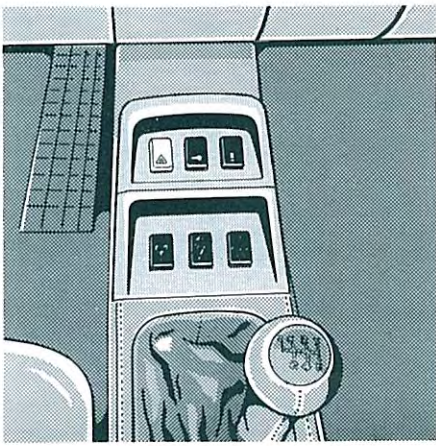

## Sun Roof

The electric sun roof is operated by a rocker switch in the centre console. Appropriate movement of the switch opens or closes the sun roof. When the switch is released the sun roof stops moving and remains in the desired position.

With the doors open, the rocker switch functions regardless of the ignition key position; with the doors closed, it can only be operated with the ignition key in position "1" or "2".

We do not recommend that the sliding roof be operated at speeds in excess of 100 km/h (60 mph). The force required to overcome the resistance of the air pressure at higher speeds can cause damage to the sun roof.

When opening or closing the sun roof, make sure that you, your passengers or bystanders have removed fingers, hands, hair etc. from the action range of the roof, as this may result in injury.

## Emergency operation

In the event of an electrical failure, the sun roof can be closed manually.

1. Open the zipper above the rear window and remove the left-hand cover.
2. Undo the tensioning screw on the drive mechanism using the angled screwdriver.
3. Insert the hand crank into the sun roof drive mechanism with the screwdriver handle and close the sun roof by turning the crank.

The cause of this fault should be eliminated as soon as possible by an Official Porsche Centre.



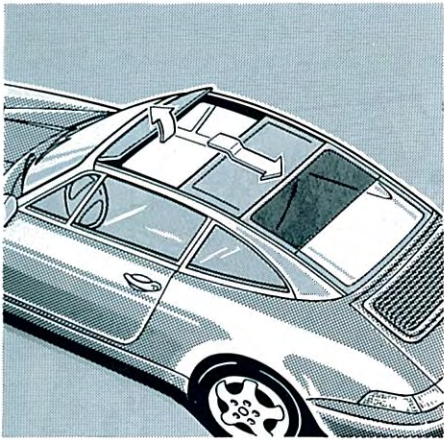

## Targa

The wind deflector, the Targa roof and the blind protecting the passengers from the sunlight or cold are driven electrically. They are operated by rocker switches located in the centre console.

With the doors open, the rocker switches function regardless of the ignition key position; with the doors closed, they can only be operated with the ignition key in position "1" or "2".

When opening or closing the roof, make sure that you, your passengers or bystanders have removed fingers, hands, hair etc. from the action range of the Targa roof, the wind deflector or the sun blind, as this may result in injury.

The action range of the Targa roof must not be limited by any piece of luggage or other objects.

26 betr.  
-gntn!

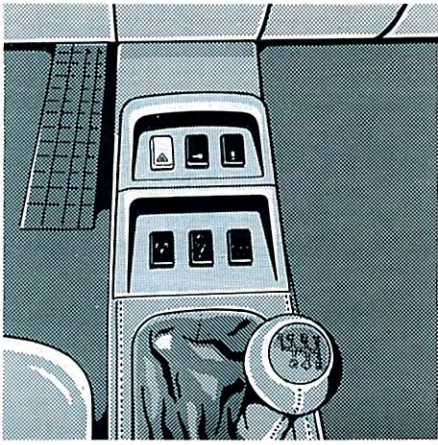

### Sun blind

The rocker switch located in the centre console facilitates infinitely adjustable unfolding or folding of the sun blind.

The sun blind can only be unfolded with the Targa roof closed; it functions regardless of the position of the wind deflector.

### Wind deflector

The rocker switch located in the centre console facilitates infinitely adjustable folding up and down of the wind deflector.

### Targa roof

#### Opening the roof

- Press the rocker switch located in the centre console until the wind deflector has folded up completely.
- Press the rocker switch one more time.

If the sun blind has been unfolded, it will be rolled up before the roof is opened.

The roof opens and will remain in the desired position as soon as the rocker switch is released.

#### Closing the roof

- Press the rocker switch until the roof has closed completely.

Press the rocker switch one more time until the wind deflector has been folded down.



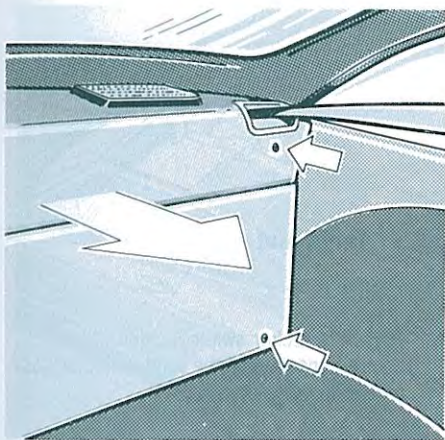

### Emergency operation

In case of a failure of the drive motors, the roof, the wind deflector and the sun blind can be closed manually.

1. Fold down rear-seat backrests.
2. Remove four screws (arrow) from the rear parcel shelf. Pull the rear parcel shelf forward carefully until the drive motors are accessible.

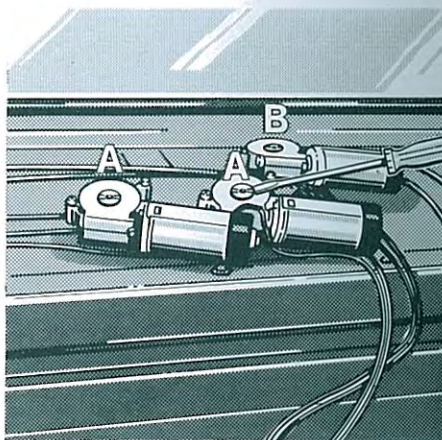

A - Drive motors for roof and wind deflector  
B - Drive motor for sun blind

3. Carefully lever the red plastic driver from the drive unit using a screw-driver blade.
4. The motor axes are rotated by an Allen key which are located in the motor section.

In case of a failure of the motor for the sun blind, rotate the motor (B) counter-clockwise until the sun blind has been rolled up.

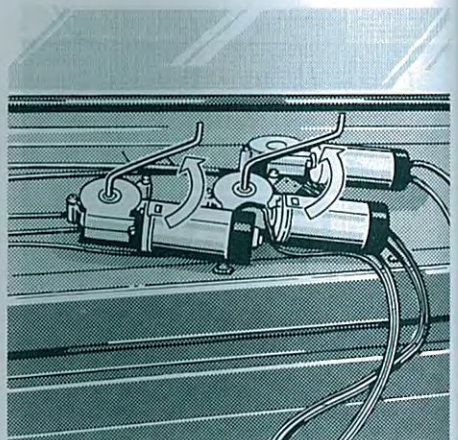

In case of a failure of the roof drive, rotate both motors counter-clockwise simultaneously until the roof and the wind deflector have been closed completely.

5. Remove the Allen key, return the plastic driver to its position and attach the rear parcel shelf.

The cause of the fault should be remedied as soon as possible by an Official Porsche Centre.

**Caution**  
You will drive  
With  
ma  
top  
Wh  
ma  
sta  
etc  
the  
inju  
When  
sure  
dama  
stop  
area  
the r  
Make  
foldin  
When  
back  
the s  
The t  
unles



## Cabriolet

You will find brief instructions on the back of the driver's sun visor.

With the windstop in place, the back seats may not be occupied during opening of the top and while it remains open.

When opening or closing the folding top, make sure that you, your passengers or bystanders have removed fingers, hands, hair etc. from between the linkage or the top and the windscreen frame, as this may result in injury.

When opening or closing the folding top, make sure that any objects or items of luggage do not damage or get in the way of the top or windstop. There should be no objects in the storage area for the folding top behind the backrests of the rear seats.

Make sure that there is enough space above the folding top.

When opening or closing the folding top, the backrests of the front seats must not be within the swinging radius of the windstop.

The folding top must not be opened or closed unless the vehicle is at a standstill.

To avoid dampstains and scratching, only open the folding top when it is dry.

Do not open the folding top at temperatures below 0°C, as the rear window may break.

The folding top must not be opened or closed with one side of the vehicle on the kerbstone, a lifting platform or a jack.

To avoid scratches on the rear window, it is advisable to wash the rear window with water if it is dirty or dusty, before opening the folding top.

Only drive with the top secured in the fully open or fully closed position.

Whenever possible, park your vehicle in the shade, as continuous sunshine will attack the fabric, rubber and colour of the top.

Do not leave the top open over long periods of time (several days). If possible, close the top overnight, as this prevents creases in the fabric and the rear window.

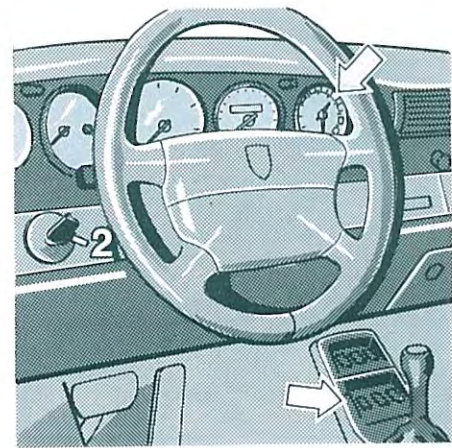

### Opening folding top

The folding top can only be opened with the parking brake set.

1. Turn the ignition key to position 2 (engine running or stopped).
2. Press the rocker switch without interruption, if possible, until the indicator light goes out (fully open position). In the event of danger, release the switch; the operation of the top will be interrupted immediately.



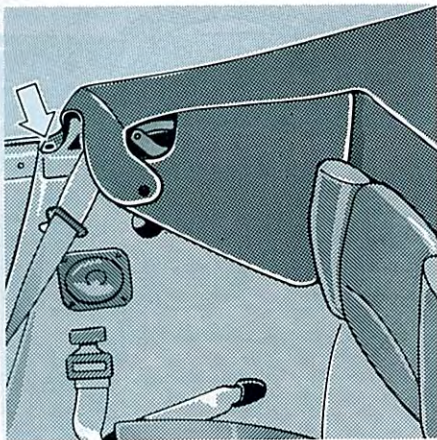

### Folding top cover

The vehicle may be driven with the top open without the folding top cover in position. However, if the top is left open for some time, the cover should always be installed to prevent damage to the inside of the top.

1. Remove the cover from the luggage compartment, place it over the open folding top and fasten the press studs provided.

Remove the covers (arrow) of the press studs.

2. The sides of the cover must be fastened to the interior by press studs; the central part of the cover must be pushed in behind the rear seat backrests.
3. When removing the folding top cover, first pull the Tenax studs, then undo them. Push the caps (arrow) of the press studs in.

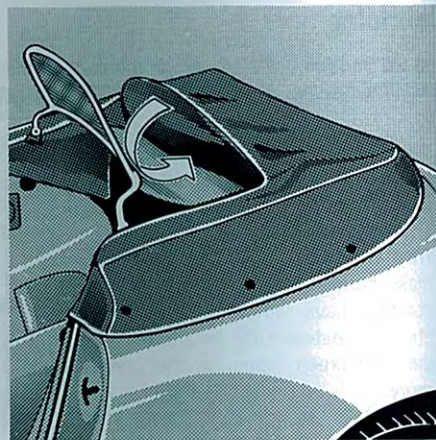

If the windstop is in position, the central part of the cover must be folded back under the cover.



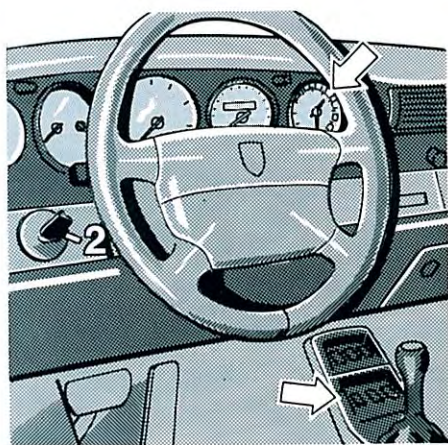

### Closing the folding top

The folding top can only be opened with the parking brake set.

1. Remove the folding top cover.
2. Turn the ignition key to position 2 (engine running or stopped).
3. Press the rocker switch without interruption, if possible, until the indicator light goes out (folding top is locked in windscreen frame). In the event of danger, release the switch; the operation of the top will be interrupted immediately.

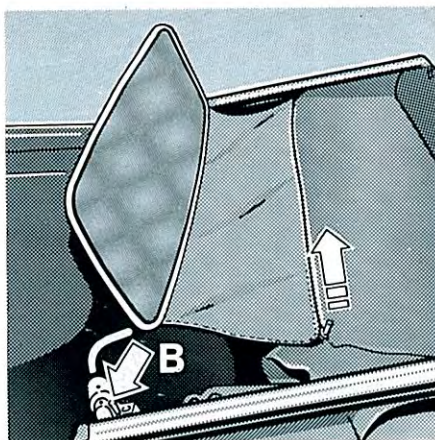

### Windstop

The windstop can also be folded back from its normal position.

#### Removing the windstop

1. Open the folding top.
2. Open the zip fastener connecting the windstop to the folding top.

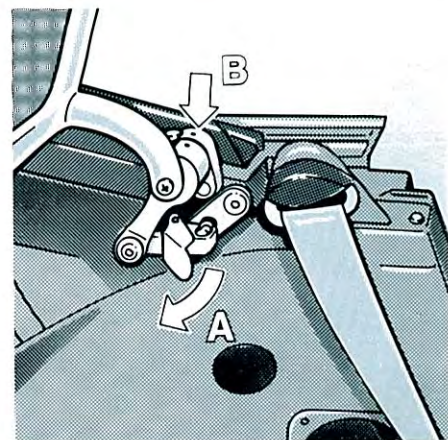

3. Swivel the red safety cap to the side. Unlatch the drag lever from the ball socket (arrow A).

4. Swing the windstop until the red mark is opposite the mark on the left mount. Press the red button (arrow B) and push the windstop out of the left mount.



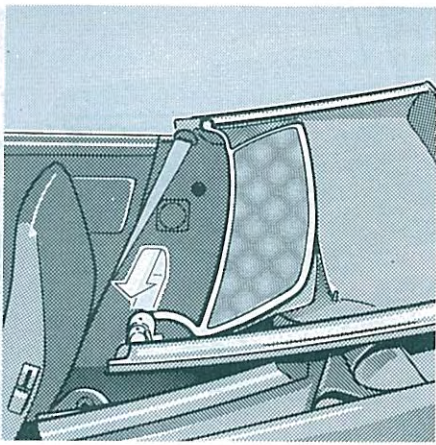

5. Pull the windstop out of the right mount.  
Place the protective cap on the ball socket.

6. Place the windstop in the bag in the luggage compartment and fix it in position with the Velcro fasteners. The fastening arms of the windstop must point downward. The windstop must not touch the luggage compartment lid.



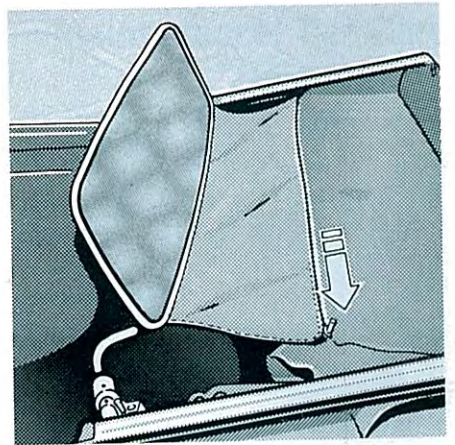
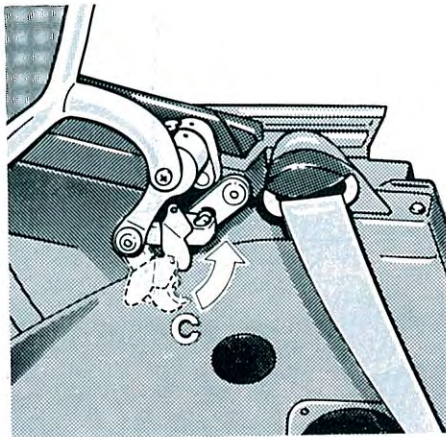
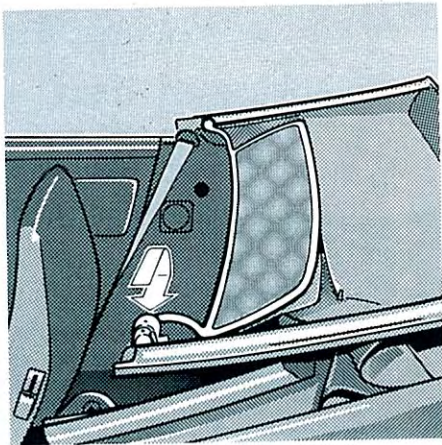

#### Installing the windstop

1. Insert the windstop first in the right mount, then in the left mount.
2. Swing the windstop until the marks on the left mount are facing each other.
3. Pull the windstop into the left mount until you feel it snap into place and it can be turned in the mount. Swing the windstop towards the front of the vehicle.
4. Remove the protective cap from the ball socket. Latch the drag lever into the ball socket (arrow C). Push the red safety cap over the drag lever until it snaps into place.
5. Connect the zip fastener of the windstop to the folding top and close the zip fastener.



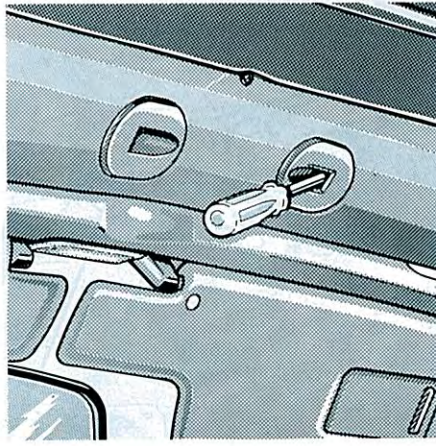
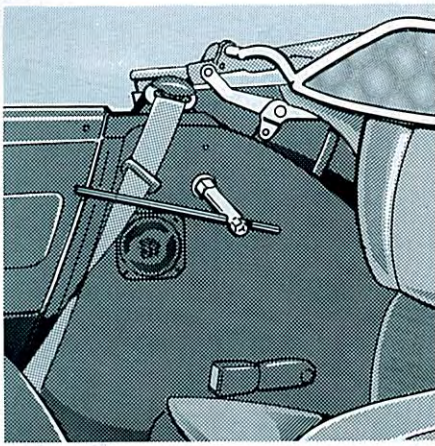

### Emergency operation

Before closing the folding top manually, check whether the fuse is intact. Refer to the section entitled "Fuses, relays".

#### If there is a fault in the electric motor:

1. Remove the cover caps from the emergency operating devices on both rear side panels.
2. Take the wheel brace from the tool kit and loosen both bolts about four turns.

3. Raise the folding top and position it carefully on the windscreen frame.

4. Press the rocker switch until the indicator light goes out.

#### If there is a fault in the folding top locks:

Turn each of the locks about 10 turns with a screwdriver, working alternately on the two locks until the folding top locks can be seen to lock (indicator light off).

The cause of the fault should be remedied as soon as possible by an Official Porsche Centre.



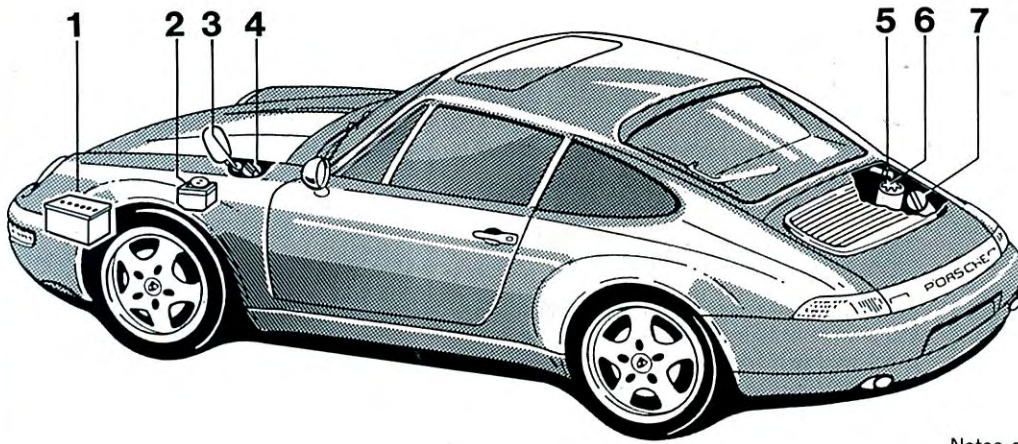

- 1 Battery
- 2 Brake fluid reservoir
- 3 Water reservoir
- 4 Fuel tank
- 5 Oil dipstick
- 6 Power steering
- 7 Top up engine oil here

Notes on maintenance.....	80
Checking engine oil level, topping up oil.....	81
Engine oils.....	82
Power-assisted steering, Carrera .....	83
Power-assisted steering and hydraulic clutch, Turbo .....	84
Brake fluid .....	85
Fuel tank and water tank .....	86
Emission control system .....	87
Car care.....	88 - 92
Winter operation.....	93, 94
Roof rack, car telephone .....	94
Radio reception, Digital sound processing .....	95



## Notes on Maintenance

As a rule, we recommend that you have all the necessary work on your Porsche carried out by an Official Porsche Centre. Training and experience of the workshop staff, technical information supplied by the manufacturer and special tools and equipment constitute a good basis for the fault-free care of your Porsche.

However, if you work on your Porsche yourself, you must exercise the greatest care. Only in this way is operational reliability fully guaranteed.

Incorrect maintenance during the guarantee period may invalidate your guarantee.

Work on your Porsche only in the open air or in well ventilated rooms.

Never smoke near or bring a naked flame into proximity with the battery or fuel system.

Before working on any part in the engine compartment, switch the engine off and let it cool down sufficiently. Be careful when working near parts of the engine which are hot – they may cause burns.

In particular, be very careful to ensure that items of clothing (ties, sleeves etc), jewelry or long hair cannot get caught in the fan, V-belts or other moving parts.

If work has to be done with the engine running, always apply the handbrake and move the gear lever to the neutral position or the selector lever to position "P".

Your Porsche is equipped with an electronic ignition system. When the ignition is on, all the cables and leads of the ignition system and the tachometer carry high tension; for this reason, extreme caution must be exercised.

Always place your Porsche on strong supports if you have to work beneath the car. The car jack is not suitable for this purpose.



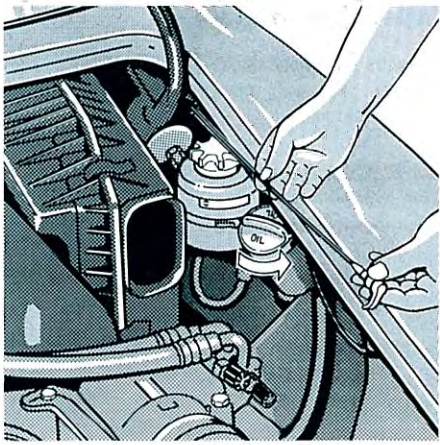

### Checking oil level in the reservoir, topping up oil

Important: there is a danger of injury if items of clothing (ties, sleeves etc.), jewelry or long hair become caught in the V-belts, fan or other moving parts. Hot engine parts constitute a burn hazard.

Be especially careful that the dipstick is not caught in the fan, V-belts or other moving parts when you pull it out.

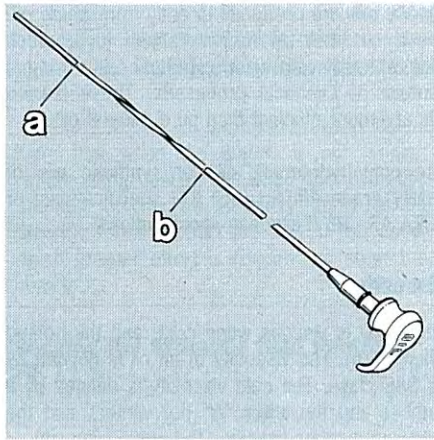

Every time you use your car and the engine gets warm, we advise you to check the oil level displayed on the oil level instrument before switching off the engine.

### Checking the engine oil level using the dipstick

Always measure the oil level with the car on a level surface and with the engine idling at normal operating temperature (oil temperature gauge in the area of the third marking).

Before measuring, the engine must be allowed to idle for thirty seconds to allow the oil to level out in the reservoir.

Pull out the dipstick, wipe it with a clean lint-free cloth, and reinsert it all the way into the tube; then pull the dipstick back out and read off the oil level.

The twisted section of the dipstick indicates the minimum (a) and maximum (b) oil levels; the level must always be between these two marks. The difference between the two marks corresponds to about 1.5 litres.

Always make sure that the dipstick is carefully inserted with the handle downward, and that it is not touching the rear lid.

### Topping up oil

Do not remove the filler cap when the vehicle is on a slant, otherwise oil may run out.

A pouring aid is built into the oil filler neck. This must be pulled out when the oil filler cap (arrow) is opened.

Do not pour in more than 0.5 liters at a time. Watch the level rise on the display instrument while topping up engine oil.

Never exceed the maximum mark when filling with oil.



## Engine Oils

Porsche engines are designed so that you do not need to use oil additives. Use only engine oils which have been tested and approved by Porsche. Your Official Porsche Centre will be glad to advise you.

These oils can be intermixed. However, since each brand of oil has a special composition, you should, if possible, use the same oil if it becomes necessary to top up between oil changes.

If your vehicle is used frequently over short distances in winter, the engine will not always be properly warmed up. Condensates from products of combustion may accumulate in the oil. In this case, it is advisable to change the oil in spring so that your engine once again has a 100% efficient engine oil.

### Oil quality

Engine oil is not only a lubricant, but also serves to keep the engine clean, to neutralize the dirt which penetrates into the engine through combustion and to protect the engine against corrosion. To perform these functions, the oil is provided with additives which have been specially developed for the purpose.

Mineral oils are produced directly from crude oil. These oils can be further refined (hydrocrack oils) or totally converted (synthetic oils) using a number of chemical processes. These refined oils are more efficient than pure mineral oils.

Use only hydrocrack oils or synthetic oils of quality grade API SH (SG) (US specifications) or ACEA A3 - 96 (European specifications).

### Viscosity

Engine oil is viscous when cold, and thin-bodied when warm. The viscosity of an oil is defined by its SAE class. The cold viscosity is defined by a number and the letter "W" (for winter), and the following number specifies the warm viscosity.

**Example:** A 10W - 30 oil and a 10W - 40 oil have the same viscosity when cold, but when hot the oil with the number 30 is thinner than the oil with the number 40.

## Single-grade/multigrade oils

Oils with two viscosities are called multigrade oils; oils with only one viscosity are termed single-grade oils.

### Oils for winter and summer

below -20°C: SAE .....5W - 30  
.....5W - 40  
.....5W - 50

above -20°C: .....10W - 30  
.....10W - 40  
.....10W - 50

Oils for summer .....15W - 40, 15W - 50  
.....20W - 40, 20W - 50

### Light running oils

Light running oils are of lower viscosity at all temperatures and therefore make it possible to save a certain amount of fuel.

Light running oils, which are designed to be suitable for year-round use, require a particularly high thermal stability. Oils with this kind of performance are non-conventional engine oils and are termed all season light running oils in the Porsche approval.

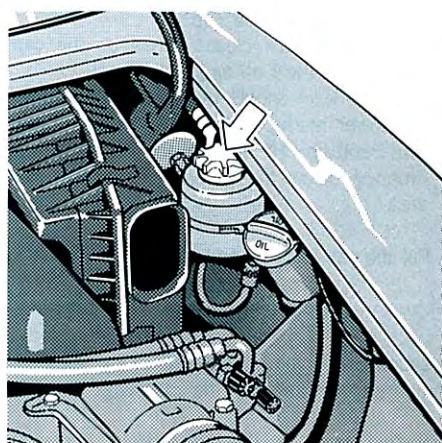

The audible rushing noise that occurs at full steering lock is a characteristic of the construction and does not indicate a fault in the steering assembly.

Note that when the engine is not running (when being towed) or when the hydraulic steering mechanism is faulty, there is no steering force support present. In this case, much greater effort is required to steer the vehicle.

### **Checking the hydraulic fluid Pentosin CHF 11 S**

The reservoir is secured in the engine compartment on the right-hand wheel housing.

### **Carrera: Reservoir for Power-assisted Steering System**

With power-assisted steering, the steering forces are assisted by a hydraulic mechanism. At low engine speeds, e.g. when parking or when driving slowly, the power-assisted steering is fully effective. The power assistance decreases with increasing engine revolutions or increasing vehicle speed and has the effect of producing increasingly positive steering action.

1. Unscrew the reservoir cap.
2. Wipe the dipstick clean. Let the engine run at idle speed. Screw on the cap and then screw it off again. The fluid level should be between the upper and lower marks. Top up with hydraulic fluid Pentosin CHF 11 S if necessary.
3. Put the cap back on and screw tight.



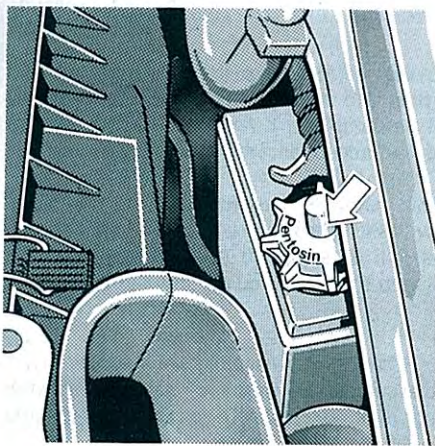

### **Turbo: Reservoir for Power-assisted Steering and Hydraulic Clutch Systems**

Power-assisted steering and clutch operation are assisted by a hydraulic mechanism.

At low engine speeds, e.g. when parking or when driving slowly, the power-assisted steering is fully effective. The power assistance decreases with increasing engine revolutions or increasing vehicle speed and has the effect of producing increasingly positive steering action.

The audible rushing noise that occurs at full steering lock is a characteristic of the construction and does not indicate a fault in the steering assembly.

Note that when the engine is not running (when being towed) or when the hydraulic mechanism is faulty, there is no steering force support present. In this case, much greater effort is required to steer the vehicle.

### **Checking the hydraulic fluid Pentosin CHF 11 S in the engine and luggage compartments**

One reservoir is secured in the engine compartment on the wheel housing wall.

#### 1. Shut off engine.

In order to exactly determine the fluid level, the pressure reservoir has to be emptied. To do this, fully depress the clutch pedal several times.

While "pumping", the required pedal pressure increases.

The pressure reservoir is empty when the pedal pressure does not increase anymore.

#### 2. Unscrew the reservoir cap.

Wipe the dipstick clean. Screw on the cap and then screw it off again.

The fluid level should be between the upper and lower marks. Only top up with hydraulic fluid Pentosin CHF 11 S, if the fluid level has dropped below the lower mark on the dipstick.

#### 3. Put the cap back on and screw tight.

A second reservoir is secured in the luggage compartment underneath the carpeting.

The fluid level in the transparent container should always be between the "MIN" and "MAX" marks.

Only top up with hydraulic fluid Pentosin CHF 11 S, if the fluid level has dropped below the lower mark.



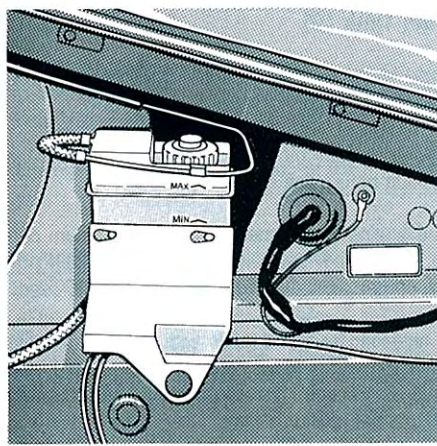

Some dropping of the fluid level occurs, when driving, due to wear and automatic adjustment of the disc brake pads. This is quite normal.

Should the fluid level drop appreciably, the brake fluid warning light comes on. Immediately contact an Official Porsche Centre to check the brake system.

Brake fluid is hygroscopic, and must therefore be replaced in accordance with the intervals specified in the booklet "Guarantee and Maintenance".

Always fill the system with new (unused) original Porsche brake fluid. For filling capacity, see chapter "Filling Capacities".

### **Brake Fluid Reservoir**

The fluid reservoir for the hydraulic brake operating system is in the luggage compartment. In case of the 911 Carrera, the hydraulic clutch operating system is also supplied from this container.

The fluid level in the transparent container should be between the "MIN" and "MAX" marks.

**Caution:**  
Brake fluid is corrosive and can damage the paintwork.



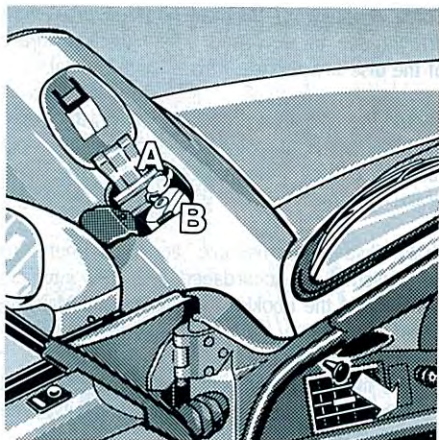

## Fuel Tank and Water Filler Necks

Both filler necks are located in the left front wing, and are covered by a flap.

A plastic apron folds out in order to protect the paintwork against dirt and damage when filling the tank. The flap is opened by pulling the release knob at the left end of the instrument panel.

## Fuel Tank (B)

Refer also to the sections "Emission control" and "Fuel gauge".

Always switch off the engine and turn off the ignition before refuelling.

The engine is designed to provide optimum performance and fuel consumption if unleaded premium fuel, minimum 98 RON / 88 MON is used.

If unleaded premium fuels with octane numbers of at least 95 RON / 85 MON are used, the engine's knock control system automatically adapts the ignition timing.

If fuel of sufficient quality is unavailable, the car can be driven for short periods, in an emergency, on lower-octane fuel. (min. 93 RON). Do not drive at full throttle.

To prevent the fuel tank overflowing as hot fuel expands, the tank has an additional space which should not be filled with fuel.

The tank is "full" when the correctly operated automatic fuel-hose nozzle cuts off.

The fuel tank filler neck is provided with a flap designed to prevent damage to the exhaust system due to the tank being filled with leaded fuel by mistake.

Only the nozzle of an unleaded-fuel pump will open this flap.

Carefully put the tank cap into its place and rotate until it engages perceptibly.

## Washer fluid reservoir (A)

The reservoir has a capacity of approx. 7 litres (1.54 Imp. galls.).

The fuel tank must be closed when the water reservoir is being filled.

It is a good idea to add the correct amount of Porsche Window Cleanser – either summer or winter grade according to the time of the year – to the water. Generally, clean water alone is not sufficient to clean the windscreen and headlights.

## Fuel Can

Prompt refuelling as well as the large tank capacity make it unnecessary to carry a fuel can.

If you are nevertheless obliged to carry a spare can, it should be securely fastened in a safe place (e.g. behind the rear seat back). Incorrectly secured cans may be damaged in an accident and the escaping fuel may increase the risk of fire or explosion.

Escaping fuel vapour or fumes can be hazardous to health.

## Emission Control System

In conjunction with the lambda sensor and the electronic control unit, the controlled three-way catalytic converter represents the most effective emission control system.

To assure the efficiency of the emission control system, always have your car serviced at the specified intervals.

The system consists of several components:

- the catalytic converter
- the lambda sensor
- the electronic control unit
- the tank ventilation system

To avoid permanent damage to the functionality of catalytic converter and lambda sensor, use only unleaded fuel.

The tank ventilation system prevents fuel vapours escaping from the tank into the atmosphere.

## Tips on driving

Faults in the mixture formation system can cause overheating and damage to the catalytic converter.

For this reason, it is imperative that the following points are observed.

- Avoid frequent and prolonged operation of the starter motor if the engine does not start.
- If backfiring occurs while driving (identifiable by rough running of the engine or loss of power), have the malfunction immediately corrected at the nearest Official Porsche Centre.
- Avoid high cornering speeds once the fuel level warning lamp has come on.
- Never drive until the fuel tank is completely empty.

## Undersealing

Do not apply additional underseal or rust protection on or near the exhaust manifold, exhaust pipes, catalytic converter or heat shields. With the engine running, the protective material may overheat and ignite.

## Parking

Never park your car or run the engine where there is a danger of flammable material such as dry grass or leaves coming into contact with the hot exhaust system.

## Tow-starting

Cars with a catalytic converter should only be tow-started or bump-started if the engine is cold.



## Car Care Instructions

Regular and correct care helps to maintain the value of your Porsche and can be a pre-condition for the vehicle guarantee and the long-life guarantee.

Your Official Porsche Centre has specially developed car care products from the Porsche range available either singly or as complete car care sets. The staff of the Centre will be pleased to help you select suitable products.

Always follow the instructions for use printed on the package.

In order to ensure that the vehicle's condition is professionally checked and the long-life guarantee remains valid for the full 10-year period, any Official Porsche Centre will inspect the level of care and maintenance of the vehicle and record the results in writing. The Centre will then make out a Status Report and certify this under "Long-Life Guarantee Status Report" in the "Guarantee and Maintenance" booklet.

## Washing

The best method of protecting your Porsche from the damaging effects of the environment is frequent washing and the application of a preservative. Once the period when roads are salted and gritted in the winter is over, at the latest, the underside of the car should also be thoroughly washed.

The longer salt, road dust and industrial dust, dead insects, bird droppings or substances from trees (resin, pollen) are allowed to remain on the bodywork, the more serious is their harmful effect.

### Caution:

Using high-pressure cleaning devices to wash your car can cause damage to the tyres. When cleaning with a flat-jet nozzle or what is known as a "dirt cutter", maintain a minimum distance of 20 cm (8"). Tyres must never be cleaned with a round-jet nozzle. If a tyre is inadvertently sprayed with a jet of water from a high-pressure nozzle, its surface should immediately be examined for possible damage. The design features of some car-wash systems can also cause damage to the wheel rims. Please ask your car-wash operator for information.

Unscrew the external aerial before using an automatic car-wash!

Door and lid seams or door sills, and other parts of the bodywork inaccessible to a car wash, must be cleaned by hand and leathered down.

Cars should be washed carefully with plenty of clear water to protect the paintwork. Dark paint finishes, especially, show up the smallest of surface damage (scratches) more readily than light colours.

Dark colours are also more susceptible to scratches because of the composition of their pigments and therefore require special care and attention. Washing a car by hand does more damage to the environment than using a car-wash system. To prevent soot, gease, oil and heavy metals from contaminating the environment, your car should only be washed at places specially designed for that purpose.

When washing by hand, use an abundant supply of water, a soft sponge or wash brush and the Porsche car shampoo. Begin by spraying the body thoroughly with water to rinse away loose dirt. Do not wash your Porsche in bright sunlight or while the bodywork is still hot. After washing, rinse the car with plenty of water and then leather dry.

Do not use the same wash leather for rubbing down as you use for cleaning the windscreen and windows.



Wet brakes can reduce braking efficiency or make the brakes pull unevenly. Always apply the brakes a few times after washing your car to test braking efficiency and dry the brake discs.

Dust should never be wiped off the car with a dry cloth since dust particles are abrasive and could dull and damage the surface finish.

### **Cleaning and care of the Cabriolet folding top**

The life and appearance of your Cabriolet folding top are to a large extent dependent on proper care and servicing.

Whenever possible, park your Porsche in shade as continuous sunshine will attack the material, rubber and colour.

Remove bird droppings immediately since the acid in them will make the rubber swell and the hood will become leaky.

Open folding top only when it is completely dry, otherwise dampstains and scrub marks may occur which cannot be removed.

Before washing, or if the folding top is dusty, brush with a soft brush in the direction of the line of the fabric. Clean rear window with a soft, anti-static cloth. The folding top does not have to be washed each time the car is washed.

It is usually sufficient to spray or wash it with clear water. Only if the folding top is extremely dirty, wet with lukewarm soapy water (e.g. washing agent for delicate fabrics) using a sponge or soft brush and rub gently. Then spray the folding top with clear water until there is no soapy solution left.

Light scratches and cloudy patches on the rear window can be removed using a suitable polish. Your Official Porsche Centre will recommend a special polish.

Do not affix stickers or adhesive strips to the rear window or cover it with plastic film. This causes discoloration and can damage the rear window.

The folding top must remain closed while drying.

If leaks develop in the folding top or at its seams and folds, they can be rectified with a sealing agent approved by Porsche.

After treatment, remove any sealing agent from the rear window or the car's body.

Never clean the folding top or rear window using white spirit, stain remover, benzene, paint thinner or solvent; they attack the layer of rubber between the fabric and endanger water-resistance and durability. Try to remove spots from the fabric of the folding top by rubbing carefully with a soft crêpe rubber.

Never remove snow and ice using a sharp-edged object.

Incorrect care and treatment can damage the folding top and the rear window and cause leaks. Any repair work or replacement of the rear window can be carried out by your Official Porsche Centre.

### **Preservation**

The paintwork contains certain fats which maintain its high lustre and prevent it becoming brittle. Climatic influences can remove these fats from the paintwork. This should be counteracted by applying a paint preservative in good time to restore the fats, preserving the high lustre and preventing dirt from settling on the surface and industrial dust penetrating the paint.



Provided it is washed and treated with preservative regularly, the brand new finish of your car will be retained for years to come. Apply the Porsche paint preservative after the car wash and polish it dry to obtain a bright finish or simply add the Porsche liquid preservative regularly to the final rinse water and rub down with a leather.

### **Cleaning and preserving engine compartment**

The engine compartment and the surface of the engine are treated with a corrosion inhibitor at the factory.

If grease solvents are used to clean the engine compartment or the engine is washed down, the process almost invariably removes the corrosion inhibiting coating. It is then absolutely necessary to have a durable preservative applied to all surfaces, body seams, joints and assemblies in the engine compartment. This also applies when corrosion-protected parts are replaced.

Effective rust-proofing is particularly important during the cold weather season. If the car is driven frequently in areas where salt has been spread on the roads, the whole engine compartment should be cleaned thoroughly after the cold weather season to prevent salt causing any lasting damage. A full underbody wash should be performed at the same time.

### **Windows**

The road dust which settles on the windscreen and windows contains particles of tyre rubber and oil residue. The interior trim and upholstery release vapours, particularly in strong sunlight, which collect on the insides of the windows. These deposits are augmented by impurities in the air which enter the car through the fresh air vents.

Porsche window-cleaning agent can be used to clean the windows, both inside and outside. Remember to clean the wiper blades as well and replace them once or twice a year, depending on condition. If you use a chamois leather for the windows, do not use it for the paintwork as it will otherwise pick up a certain amount of the preservative or polish and could smear the windows and thus impair vision.

Remove dead insects with the Porsche insect remover.

### **Polishing**

Do not resort to using Porsche polish until it becomes evident that the normal preservatives no longer produce the desired finish.

#### **Caution:**

Do not apply silicone polishes to the windscreen or windows.

The paintwork of your Porsche is exposed to all manner of mechanical and chemical stresses, particularly climatic ones such as bright sunlight, rain, frost and snow. Ultraviolet light, rapid changes in temperature, rain, snow, industrial dust and chemical deposits constantly attack the paint which is only able to withstand such exposure in the long term if it is given regular and expert care and attention.

Matt finished parts should not be treated with preservatives or polishes as this will spoil the matt effect.

### **Spots and stains**

Tar stains, grease, oil spots and dead insects cannot always be removed by washing alone. They can cause discoloration if allowed to remain on the paintwork. They should therefore be removed without delay with insect remover.

Wash the affected area immediately after treating it.



### Minor paint damage

Minor paint damage, such as scratches, scores or chips caused by flying stones, should be touched up immediately by your Official Porsche Centre before corrosion sets in. However, if there are already traces of corrosion they must first be removed carefully and thoroughly. The area is then coated with a rust-proofing primer and finished off with a top coat. The paint code and colour number are to be found on the vehicle's paint-data plate.

### Undersealing

The underside of your Porsche is durably protected against chemical and mechanical influences.

As it is not possible to exclude the risk of damage to this protective coating in day-to-day driving, it is advisable to have the underside of the car inspected at certain intervals – preferably before the start of the cold season and again in spring – and the undersealing repaired as necessary.

Your Official Porsche Centre is familiar with the bodyseal treatment procedures and has the necessary equipment for applying factory-approved materials. We recommend that you entrust the Centre with all such work and inspections.

Unlike conventional spray oils, undersealing and rust-proofing compounds based on bitumen or wax do not attack the antidrumming materials applied at the factory.

Before applying fresh underseal, carefully remove deposits of dirt and grease. Once it has dried, the new undersealing compound forms a tough protective coating which provides efficient rust-proofing for the floor panels and components.

Do not apply any underseal on or near the exhaust manifold, exhaust pipes, catalytic converter or heat shields. The heat from these items may cause the protective material to overheat and ignite.

Always apply a fresh coating of suitable preservative to unprotected areas after cleaning the underside of the body or the engine or carrying out repairs to underbody components.

### Lights, plastics

Use only soap and water solution for cleaning the plastic light lenses. Never use chemical cleaning agents for the purpose. The same applies to other plastic parts and plastic films.

### Door, roof, lid and window seals

As they age, rubber seals can become brittle, cracked, and inelastic. Treat them regularly with glycerine or talcum powder.

### Light alloy wheels

Pitting can occur if metallic particles which cause contact corrosion (e.g. brass or copper in brake dust) are allowed to remain on the light alloy for too long.

Regular care is necessary in order to retain the attractive surface finish. The wheels should be washed down with a sponge or wash brush about every two weeks. In areas where salt is spread on winter roads or there is a lot of airborne industrial dust, it is best to clean the wheels weekly.

The Porsche Light Alloy Wheel Cleaner (pH-value 9.5) can be used for this purpose. If the pH-value of the detergents is incorrect, the protective coating on the wheels may be destroyed.

Every three months you should coat the wheels with a non-corrosive grease (vaseline) after cleaning. Using a clean cloth thoroughly rub the grease into the surface.



Polishes which dissolve oxides, as frequently used for other metals, or abrasive tools or agents are unsuitable because they break down the oxide film of the protective coating.

### **Leather care**

Leather is a natural material. The tanned hide is a product of nature. The natural surface markings of leather skins, such as creases, healed scars, insect sting marks, structural differences and slight variations in shade and grain add to the attractiveness of the real leather product.

We recommend that leather be treated or cleaned initially after the first few weeks or after the car has covered a few thousand miles. Only by doing so can the leather patina, which emphasizes the inherent qualities of the upholstery, begin to form.

Cleaning is best performed with a white, soft woolen cloth and a cleaning agent with a neutral soap basis (mild soap and water solution). If the leather is heavily soiled the Porsche Cockpit cleaner can also be used. Please follow the instructions on the containers carefully.

Do not use aggressive cleaners or hard objects.

Take special care not to dampen the other side of perforated leather trim.

Once you have cleaned the leather (especially the heavily used leather seats) treat it with the Porsche Leather Care Agent. Leather should be cleaned and treated several times a year, depending on how quickly it becomes dirty.

### **Fabric upholstery and carpets**

Use only a vacuum cleaner or a medium stiff brush. Remove stains and spots with Porsche stain remover.

The Porsche range of accessories includes floor mats to protect the carpeting.

### **Care of the seatbelts**

If it becomes necessary to clean the belts, any mild cleaning agent may be used. Allow the belts to dry, but avoid direct sunlight.

If unsuitable cleaners are used or any attempt is made to dye or bleach the belts, the webbing may be weakened and thus constitute a safety risk.

### **Storing your Porsche**

If you intend to store your Porsche for a prolonged period, please consult your Official Porsche Centre. The staff will be glad to advise you on the most suitable and necessary methods of corrosion protection.

## Hints for Winter Operation

### Engine oil

If you use exclusively those oils listed in the chapter "Engine Oils" you will be largely unaffected by seasonal temperature changes.

### Brakes

After driving for extended periods on salt-covered roads it is possible that a film will build up on the brake discs and pads which considerably reduces friction and thus the braking efficiency.

The brake discs and brake pads should therefore be cleaned every two weeks or so with a powerful water jet. The cleansing effect of automatic car washes is insufficient.

### Battery

When outside temperatures fall, the battery's capacity decreases while the load placed on it increases considerably. Therefore, check the condition of the battery in time and have it charged, if necessary. Check also the electrolyte level and apply terminal protecting grease to the connectors. Also see the section entitled "Battery".

### Corrosion protection

The salt spread on winter roads can have a detrimental effect on your car's bodywork. You should therefore wash the car as often as convenient in accordance with our car care instructions. Have a preservative applied and the underseal checked by an Official Porsche Centre before and after the cold weather season.

### Door locks

In order to prevent the door locks from freezing, tape the lock cylinders when washing your car during the cold season. To open a frozen lock, apply a commercial de-icer. Another solution is a warmed-up key. Never apply any force.

### Washer reservoir

To ensure that the windscreen washer and the headlight washer function even in freezing temperatures, add a winter cleaner with frost protection before frost sets in, in the proportions specified by the manufacturer.

### Door, roof, lid and window seals

To prevent freezing of the rubber seals, it is recommended that the rubber be lightly coated with either glycerine or talcum powder.

### Winter tyres and snow chains

Because of the limited effectiveness of summer tyres in winter, the winter tyres recommended by Porsche should be fitted to all four wheels in good time before the anticipated arrival of snow and ice.

Snow chains can be fitted only to the rear wheels, and only with the tyre/rim combinations listed in the Technical Data.

To ensure adequate clearance between chain and wheel arch, use only the fine-link chains recommended and approved by Porsche.

Remove hardened snow and ice from inside the wheel arches before fitting snow chains.

Different countries have varying statutory requirements governing maximum speed, which must be observed.



When fitting the wheels, ensure that the coloured wheel bolt is opposite the wheel valve.

When removing, mark the direction of rotation and position on each wheel.

For example:

FR (front right), FL, RR and RL.

Make sure that the wheels are fitted in accordance with these markings.

#### Note

It can be helpful during winter to keep a handbrush and scraper in your Porsche to clear the windows of ice and snow, as well as a board to put under the jack and some dry sand to help traction when pulling away on icy slopes.

## Roof Racks

Normal commercially available roof racks cannot be fitted.

If an original Porsche rack (as available to date) is fitted, the permitted roof load is 35 kg (77 lbs).

With the "Porsche Roof Transport System" you can transport a wide variety of sports and hobby equipment, up to a roof load of 75 kg (165 lbs).

Your Official Porsche Centre will be glad to advise you on the versatility of the "Roof Transport System".

To ensure minimum noise, maximum economy and a desirable level of safety when driving with an unloaded roof rack, you should not exceed a maximum speed of 180 km/h (110 mph). When the roof rack is loaded, the recommended maximum speed depends on the nature, size and weight of the load. You should not, however, exceed a speed of 140 km/h (85 mph) at any time.

Make sure that the load is carefully mounted. Secure it additionally by locking the roof transport system. Refer to the separate fitting instructions for the roof transport system.

## Car Telephone

Mobile communication systems (car telephone, 2-way radio etc.) should only be installed at a professional workshop.

Incorrectly installed units or antennas inside the passenger compartment may cause interference to vehicle electronic systems when the radio is operated.

To prevent damaging your health, a telephone with an antenna integrated into the handset must not be used inside the vehicle unless only it is connected to an external antenna.

The reception quality of your car telephone will change constantly when you are driving. Interference caused by buildings, landscape and weather is unavoidable. It may become particularly difficult to hear when using the hands-free function due to external noise such as engine and wind noise.

It is essential to observe the instructions of the telephone manufacturer before putting it into operation.

Unscrew the external aerial before using an automatic car-wash!

## Radio Reception

The reception quality of your car radio changes constantly while you are driving. Interference due to buildings, topographic features or the weather are inevitable. FM stereo reception is particularly sensitive to changing conditions. To suppress interference, you can switch your radio over to mono operation or select a different FM stereo channel.

Refer to the separate radio operating instructions.

## Digital Sound Processing

Sound control by Digital Sound Processing (DSP) is executed over the control unit in the oddments tray of the driver's door. Music and speech are digitally processed in the DSP amplifier. This allows targeted sound adaptation to the vehicle, a speed-dependent sound and volume control and even an expansion of the auditory spatial sensation.

### Setting of the sound variations:



#### Speed-dependent control:

Volume and bass effect are automatically adapted to driving conditions.

#### Sound settings:



Bass accentuated sound setting



Optimal vehicle-adapted sound setting



Sound setting with spatial effect:  
small room



Sound setting with spatial effect:  
large room



Sound setting with spatial effect:  
small room optimized for driver's seat



Sound setting with spatial effect:  
large room optimized for driver's seat



## Practical Tips, Minor Repairs

Notes on Minor Repairs.....	98
Warning Triangle, First Aid Kit.....	98
Tool Kit, Car Jack.....	98
Tyres and Tyre Care.....	99 - 101
Spare Wheel.....	102
Security Wheel Nuts.....	103
Changing a Wheel.....	104, 105
Jacking Up the Vehicle.....	104, 105
Fuses and Relays.....	106
Battery.....	107 - 109
Jump Lead Starting.....	110
Changing Bulbs.....	111 - 117
Adjusting Headlights.....	118, 119
Towing and Tow Starting.....	120

## Notes on Minor Repairs

As a rule, we recommend that you have all the necessary work on your Porsche carried out by an Official Porsche Centre. Training and experience of the workshop staff, technical information supplied by the manufacturer and special tools and equipment constitute a good basis for the fault-free care of your Porsche.

However, if you work on your Porsche yourself, you must exercise the greatest care. Only in this way is operational reliability fully guaranteed.

Incorrect maintenance during the guarantee period may invalidate your guarantee.

Work on your Porsche only in the open air or in well ventilated rooms.

Never smoke near or bring a naked flame into proximity with the battery or fuel system.

Before working on any part in the engine compartment, switch the engine off and let it cool down sufficiently. Be careful when working near parts of the engine which are hot – they may cause burns.

In particular, be very careful to ensure that items of clothing (ties, sleeves etc), jewelry or long hair cannot get caught in the fan, V-belts or other moving parts.

If work has to be done with the engine running, always apply the handbrake and move the gear lever to the neutral position or the selector lever to position "P".

Your Porsche is equipped with an electronic ignition system. When the ignition is on, all the cables and leads of the ignition system and the tachometer carry high tension; for this reason, extreme caution must be exercised.

Always place your Porsche on strong supports if you have to work beneath the car. The car jack is not suitable for this purpose.

## Warning Triangle, First Aid Kit

The warning triangle may be stored in the special pocket fitted to the back panel of the luggage compartment, and the first aid kit at the front right, under the lock cross member.

## Tool Kit, Car Jack

The tool kit, the jack, the compressor, the tyre pressure gauge plus a plastic sheet to store the damaged wheel are kept in the collapsible spare wheel under the floor mat.



Some countries require additional tools and replacement parts to be carried in the vehicle. Please enquire before driving abroad.

The jack supplied with the vehicle should only be used when changing the wheels. When working under the vehicle, you should only use purpose-built stands, for your own safety.



## Tyres and Tyre Care

Steel-belted radial tyres are high-quality engineered products. The service life of your tyres will depend on your driving style as well as correct air pressure and proper wheel alignment. Abrupt acceleration, high cornering speeds and heavy braking increase tyre wear. Tread wear is also greater at higher temperatures and on rough road surfaces. Like the engine, tyres must always operate under the right conditions. If treated properly they will be a long-lasting safety element on your Porsche. The following tips will show you what to do. To protect yourself and other road users, it is absolutely essential that you follow these rules.

### Tyre pressure

Tyres must be kept at the prescribed pressure indicated on page 4 of this Manual and above the lock on the driver's door. This pressure applies when the tyres are cold, and represents an absolute minimum. The pressure will be higher in a warm tyre. Therefore, never let air out of hot tyres: the pressure might drop below the minimum value.

Tyre pressure must be checked every 14 days. Always check pressures when the tyres are cold.

Valve caps protect the valves against dust and dirt as well as leaks. Always screw the caps down tightly, and replace missing caps immediately.

Insufficient pressure can cause the tyres to overheat and suffer internal damage. Hidden tyre damage cannot be reversed by subsequent corrections in air pressure.

### Load and speed

Do not overload your Porsche. Never exceed specified roof loads. A combination of overloading + low tyre pressures + high speed + high outside temperature (on vacation trips, for example) is extremely dangerous.

### Kerbs

Drive over kerbs slowly, preferably at a right angle. Avoid driving over steep or sharp kerbs. Impacts at high speed or sharp angles against kerbs or other sharp-edged objects (like stones) can lead to concealed tyre damage that will not be noticed until later (risk of tyre failure at high speeds). Tyres never forget!

Depending on the force of impact, the edge of the rim can also be damaged.

If you are in doubt, have the wheel checked by an expert, particularly if you suspect damage on the inside.

## Tyre damage

Examine tyres at regular intervals for foreign objects, nicks, cuts, cracks and bulges (in the sidewalls). If a tyre is damaged and you cannot absolutely rule out the possibility that a ply has broken (with all the resulting consequences), or that the tyre has been thermally and mechanically overloaded due to a loss of pressure or other damage, we recommend that the tyre be replaced for safety reasons. Even invisible damage to a tyre can lead to a blowout at high speeds. Tyres must never be repaired.

When replacing a defective tyre, note that the difference in tread depth on the same axle must be no more than 30%. Never install a used tyre if you do not know its prior history!

## Storing tyres

Always store tyres in a cool, dry, dark place. Avoid contact with fuel, oil or grease.

There is no truth to the idea that tyres wear better after storage and aging. Chemical additives that make the rubber elastic lose their effectiveness over time, and the rubber becomes brittle. Tyres must never be more than 6 years old.

The age of a tyre can be determined from the "DOT" code on the sidewall (pump up the spare tyre). For example, if the last three digits are 126, the tyre was manufactured in the 12th week of 1996.

## Tread

The risk of aquaplaning increases as tread depth decreases. For safety reasons, tyres should be replaced before the wear indicators (webs in the tread grooves, 1.6 mm high) appear.

Check tyres regularly, especially before and after long journeys.

## Balancing

As a precaution, have the wheels balanced in spring (summer tyres) and before winter starts (M + S tyres). Make sure that only approved weights are used for balancing (self-adhesive weights must not come into contact with cleaning agents, otherwise they might drop off). Uneven tread wear indicates incorrect wheel balance. Consult a tyre specialist.

### Carrera 4, Carrera 4S, Turbo:

For precision balancing, all four wheels must be off the ground and able to rotate freely.

When fitting the wheels, ensure that the coloured wheel bolt is opposite the wheel valve.

When removing, mark the direction of rotation and position on each wheel.

### For example:

FR (front right), FL, RR and RL.

Make sure that the wheels are fitted in accordance with these markings.

In case of irregular running or vibrations occurring while driving and indicating a damage to the tyre or the vehicle, the speed must be reduced immediately without abrupt braking manoeuvres. Stop the vehicle and check the tyres. If the cause of the fault cannot be detected, carefully drive the vehicle to the nearest Official Porsche Centre.

If you continue your trip without having the cause of the fault remedied, you might lose control of your vehicle.



## Replacing tyres

There is no binding standard concerning permitted top speed for ZR tyres above 240 km/h.

For this reason and because of noise emission regulations, certain makes and types of tyres are binding; for some countries these makes and types are explicitly indicated in the vehicle registration.

Please ask your Official Porsche Centre about the latest authorization situation before fitting new tyres to your Porsche.

Only tyres from a single manufacturer and of a single type should be combined.

During the initial break-in period, new tyres do not have their full grip. Therefore, you should only drive at moderate speeds for the first 100 – 200 km.

When fitting new tyres to only one axle, a marked difference may be noticeable in the previously experienced driving behaviour due to the different tread depth from one axle to the other. This is especially true when fitting new tyres to the rear axle. With increasing tyre mileage, however, this effect will continuously diminish. Please adjust your driving accordingly.

Have tyres fitted by a specialist.

## Valves:

Rubber valves must be replaced every time a tyre is replaced.

For steel valves, the fitting and replacement instructions must be observed.

Only use genuine Porsche steel valves.

## Winter tyres

Do not exceed the maximum speed limit.

### Examples:

190 km/h / 120 mph for M + S T radial tyres  
210 km/h / 130 mph for M + S H radial tyres

The designation letter is visible on the tyre sidewall.

An appropriate sticker must be placed in the driver's field of vision.

Winter tyres lose their effectiveness if the tread depth goes below 4 mm.



## Spare Wheel

The jack, the compressor, the tyre pressure gauge, the tool kit plus a plastic sheet to store the damaged wheel are kept in the spare wheel under the carpet.

The following instructions on using the spare wheel must be followed precisely for reasons of safety!

The spare wheel is fitted with a collapsible tyre, and when it is needed, it must be inflated with the electric compressor. The compressor plugs into the socket of the cigarette lighter.

The collapsible spare wheel must be mounted on the vehicle before it is inflated.

Necessary tyre pressure: 2.5 bar (36 psi).

Set the pressure precisely with the pressure tester. Relieve excess air pressure by pressing down the valve core.

The spare wheel with the collapsible tyre may only be used in an emergency, for short distances.

The maximum speed for this tyre is 80 km/h (50 mph) and this speed must not be exceeded because of the changed handling characteristics of the vehicle, and the wearing properties of the tyre. The same law applies to depth of tread for this tyre as for the normal tyres.

The vehicle may only be fitted with one collapsible tyre.

The collapsible tyre expands through warming up as it is used. When deflating the tyre (completely remove the valve core), it requires several hours to cool down and thereby assume its original form, before it can be replaced in the well in the luggage compartment.

The collapsible tyre can be neither repaired nor mounted in a normal workshop. All work on these tyres must be left to the manufacturer. If the collapsible tyre develops a fault, please consult your Official Porsche Centre.

### Carrera S

If spacers are fitted on the rear axle, the spacer must be unscrewed from the corresponding wheel hub before the spare wheel is fitted. The spare wheel must be fitted only after the spacer has been removed.



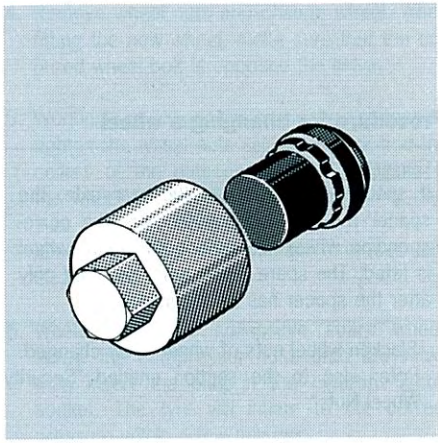

### Security Wheel Nuts

One of the wheel nuts on each wheel is fitted with an anti-theft protection device.

For loosening and tightening these wheel nuts a specially coded socket has to be used as an adapter between the wheel nut and the wheel brace.

The socket is located in the spare wheel

When pressing on the socket, ensure that it engages fully in the teeth of the wheel nut.

When you bring your Porsche to the workshop for jobs involving removal of the wheels, remember to hand over the socket for the security wheel nuts together with the car key.



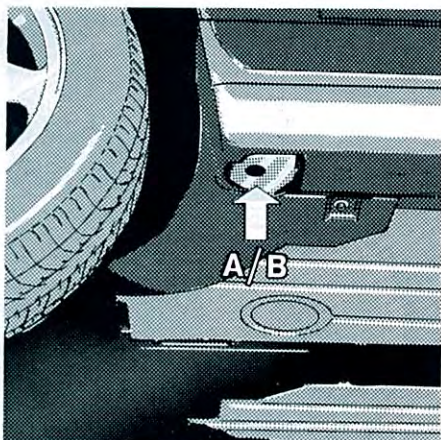

Front  
A - Car Jack  
B - Platform Lift

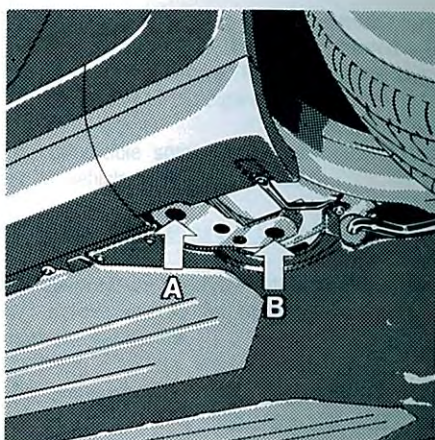

Rear  
A - Car Jack  
B - Platform Lift

## Changing a Wheel

If you have a flat tyre, move off the road as far as possible, turn on the hazard warning lights and set up a warning triangle at a suitable distance from the car.

Place the car jack on a firm, level support.

Apply the handbrake firmly, engage 1st gear or move the gear selector to "P".

The car must be secured against uncontrolled roll off, e.g. by wedges under the wheels on the opposite side. This is of special importance on an upgrade.

Do not allow anyone to sit in the car while it is jacked up.

## Procedure for changing a wheel

### Carrera S

If spacers are fitted on the rear axle, the spacer must be unscrewed from the corresponding wheel hub before the spare wheel is fitted. The spare wheel must be fitted only after the spacer has been removed.

1. Slacken wheel nuts of wheel to be changed. Refer also to the section entitled "Security Wheel Nuts".
2. The car jack must only be positioned at one of the jacking points marked "A". Make sure that the jack engages positively in the recess on the vehicle.
3. Attach crank to car jack. Raise car on jack until wheel to be changed is clear of ground.

### Warning:

The jack is only provided to lift the vehicle for changing wheels. If work is to be carried out under the vehicle, the vehicle must be supported on a suitable chassis stand or similar.



4. Remove wheel nuts and change wheel. When fitting the new wheel, make sure that the coloured wheel bolt is opposite the valve.
5. Working in diagonally opposite sequence, tighten the wheel nuts slightly. Check that the collars of the nuts engage the recesses in the wheel so that the wheel is properly centred.  
Make sure that the contact surfaces are clean.
6. When fitting the collapsible spare wheel, screw the compressor hose onto the valve, then insert the plug in the cigarette-lighter socket. The tyre will inflate to the correct pressure within a few minutes.
7. Lower car and remove jack.
8. Tighten wheel nuts fully in diagonally opposite sequence.
9. Check the pressure with the pressure gauge.

After changing a wheel, the prescribed wheel nut torque must be checked with a torque wrench as soon as possible (tightening torque 130 Nm (94 ftlb)).

### Lifting the Vehicle with a Lifting Platform or Trolley Jack

The car may only be lifted at the points "B" shown in the illustrations.

Before driving over the lifting platform, ensure that there is enough clearance between the underside of the vehicle and the lifting platform.

The vehicle should never, under any circumstances, be jacked up by the oil sump, the gearbox or the axles, as this could cause severe damage.



Luggage Compartment

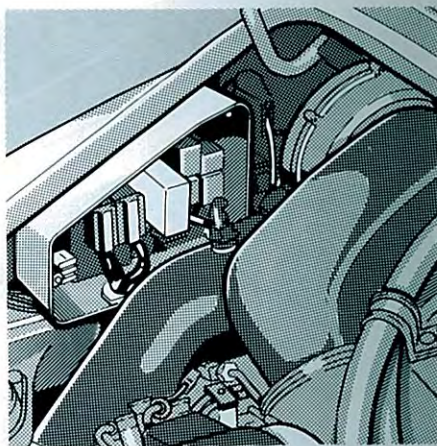

Engine Compartment

## Fuses and Relays

To prevent damage to cables and electrical devices as a result of short circuits and overloading, the individual circuits are protected by fuses.

There are two fuse boxes, both with black plastic covers; they are located on the right-hand side of the engine compartment and of the luggage compartment, respectively.

A diagram of fuse and relay assignments is located on the inside of the compartment lids.

Because of the danger of short-circuits, always disconnect the battery before beginning work on the electrical system.

If the battery is disconnected, the data for the engine electronics stored in the control unit are erased. When the battery is reconnected, the engine should be run for approx. 10 minutes to allow the control unit to re-acquire these data. During this period, the engine may idle unevenly or too fast.

## Changing a fuse

Switch off the affected system.

You can detect a blown fuse by the melted metal strip.

To test or replace a fuse, it must be removed from the spring clamp using the plastic gripper (A). As a replacement, use only fuses of the same rating.

### Note:

Should a fuse blow several times, an Official Porsche Centre should be consulted.

It is advisable to carry spare fuses of the different ratings in the vehicle.

In the main fuse box there are spaces for spare fuses.

## Relays

The testing and replacing of a defective relay should be performed by an Official Porsche Centre.

However, to prevent damage to electrical or electronic components, you are advised to have the fitting of electrical accessories done by your Official Porsche Centre. Only use accessories approved by Porsche.



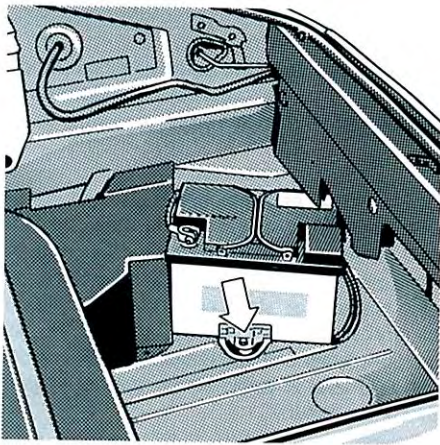

## Battery

The battery is located in the luggage compartment next to the spare wheel.

To avoid any risk of short circuits, always disconnect the battery by taking off the ground cable when working on the electrical system.

Make sure that no tools or conductive items (e.g. rings, bracelets, watch straps) get into contact with live vehicle components.  
Danger of injury due to short circuits!

Observe warning notes on the battery:



Read Driver's Manual



Wear eye protection



Keep out of the reach of children



Danger of explosion:

A highly explosive electrolytic gas mixture is formed when the battery is being charged. Observe the following precautions:



Avoid fire, sparks, naked flames and do not smoke:

Avoid generating sparks or short circuits when handling wires and electrical devices.

An increased risk of electrolytic gas formation persists on batteries with central venting. Do not kink the vent hose and do not allow it to get plugged with dirt.



Danger of acid burns:

Battery acid is extremely caustic.  
Always wear protective gloves and eye

protection. Do not tilt battery as acid may leak out past the vent hole.

First Aid:

If acid splash gets into eyes, rinse immediately for several minutes with clear water.

Neutralize acid splash on skin or clothing immediately with soap solution and rinse liberally with water.

If acid was swallowed inadvertently, consult a doctor immediately.



Disposal:

Return old batteries to appropriate waste disposal center.

Never dispose of old batteries through domestic waste outlets.

When the battery is disconnected with the engine running, the alternator and the control units may be destroyed. This is also applicable to vehicles fitted with a battery disconnect switch.

Data stored in control units are erased when the battery is disconnected and must be reentered after the battery is reconnected (e.g. radio anti-theft code).



After reconnecting the battery, the engine electronics control unit requires the engine to idle for approx. 10 minutes to allow it to retrieve the data. Idle may be too high or erratic during this period.

A well-charged battery protects against starting problems and increases battery life.

Due to traffic density, speed limits, noise, exhaust emission and fuel consumption requirements the rpm potential of the alternator and, hence, its output, have decreased.

Current requirements have increased considerably due to the increased number of electrical loads.

Make sure that electrical loads that are not needed are switched off, particularly during city driving and short trips.

### Removing and installing the battery

Take out spare wheel before removing the battery. Switch off engine and all electrical loads. The wrenches required for removing the battery may be found in the car tool kit. Start by disconnecting the ground cable when removing the battery, and reconnect the positive cable first when refitting the battery. Do not tilt battery as acid may otherwise spill out.

### Winter driving

The current output potential of the battery will obviously decrease at lower outside temperatures.

In addition, the battery is exposed to higher loads due to operation of the rear window heater, increased use of auxiliary lights, fan, wipers etc.

Have the battery condition checked by your Official Porsche Centre before the winter season.

To prevent the battery from freezing, always keep it fully charged. While a discharged battery may already freeze at  $-10^{\circ}\text{C}$ , a fully charged battery will not freeze until  $-40^{\circ}\text{C}$ .

### Battery care

Keep top of battery and terminals clean and dry. Make sure cell plugs and both terminal connectors are securely fitted.

#### Checking battery acid level:

Screw out all cell plugs.

With the vehicle on a level surface, the battery acid inside each cell must be on a level with the filler mark. The filler marks are visible at the plug openings as steps or lateral lugs inside the battery. Additional marks to indicate the fluid level are found on the battery outside.

The fluid level is visible across the cell walls by its darker colour.

If the battery requires topping up, add only distilled water (no acid).

Use only clean containers for topping up. Never allow alcohol (e.g. windshield cleaner residues) to get into the battery.

Never fill in more fluid than absolutely necessary.

Check battery acid level more frequently in summer months and in predominantly hot regions.



#### Charging the battery:

If the vehicle is used mostly in town and for short trips, or when appliances with high current consumption are operated (phone, fax etc.), the battery may have to be recharged from time to time.

Check for sufficient room ventilation when charging the battery.

Disconnect battery cables (see: Removing and installing the battery).

Observe instructions of battery charger manufacturer.

Plug in mains plug or switch on charger only if battery charger has been connected correctly.

Check acid level after charging.

Your Official Porsche Centre will be glad to advise you on a suitable charger.

#### **Replacing the battery**

The service life of the battery is subject to normal wear; it depends greatly on care, climatic conditions, and driving conditions (distances, loads)

The service life of the battery is subject to normal wear; it depends greatly on care, climatic conditions and driving conditions (distances, loads).

Use only a Genuine Porsche Battery with the correct Part No. to replace your battery.

The data on the battery housing will not allow identification of a suitable matching battery that meets all the specific Porsche requirements.

Please observe all the relevant battery disposal specifications.

#### **Laying up the vehicle**

Keep doors and hoods closed when vehicle remains off the road for longer periods and stays in the garage or workshop. Remove ignition key from the lock and disconnect battery if required. The alarm system is inoperative when the battery is disconnected!

Even if you lay up your car, the battery will discharge itself. To keep the battery serviceable, recharge it approx. every 6 weeks, checking the battery acid level at the same time and topping up if required.

Store removed battery in a dark and cool but frost-free place.

## Jump Lead Starting

If the battery is discharged, e.g. in winter time, or after your Porsche has been laid up for a prolonged period of time, the battery of another vehicle can be used as an auxiliary. For this you will need jump leads.

Refer to the section entitled "Battery" and observe the following instructions under all circumstances:

1. Both batteries must be 12-volt batteries. The capacity (Ah) of the feed battery must not be too much lower than that of the flat battery.
2. Only standardized jump leads of sufficient cross-section and fitted with insulated terminal clamps may be used. Always follow the manufacturer's instructions.
3. A flat battery can freeze at  $-10^{\circ}\text{C}$ . A frozen battery must be thawed out before jump cables are connected to it.
4. There should be no contact between the vehicles. Otherwise, current may flow as soon as the positive terminals are connected.  
Danger of short-circuit!
5. The flat battery must be correctly connected to its vehicle's electrical system. Do not stoop over the battery.  
Danger of contact with caustic fluid!

6. Protect the battery from sources of fire such as naked flames, burning cigarettes, sparks caused by electrical wiring or welding etc.

### Danger of explosion!

Be careful not to allow conductive jewelry such as rings, necklaces, watchstraps etc. to come into contact with live parts of the car.

There is a danger of injury due to short-circuits.

7. Connect the jump leads in such a way that they cannot be caught up by rotating parts in the engine compartment.

### Connect the jump leads as follows:

First connect the + lead to the + terminal of the feed battery (A), then to the + terminal of the flat battery (B), then

connect the - lead first to the - terminal of the flat battery,

then connect the other end to a suitable earthing point (4) on the body of the car with the feed battery.

This earthing point must be as far as possible from the battery.

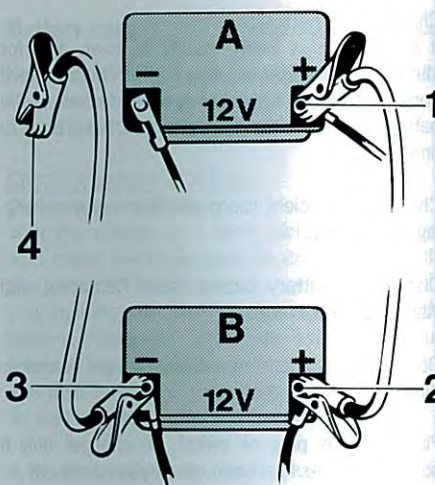

A - Feed battery  
B - Flat battery

8. Start the engine of the vehicle with the supplying current. Run engine with higher rpm.
9. Start the engine. Do not crank the engine for more than 15 seconds; wait for at least 1 minute before repeating the attempt.
10. With the engine running, disconnect the cables in the reverse order.



## Bulb Chart

	Socket	Type, rating
High beam headlight	P 14.5 E	H1, 55 W
Dipped beam headlight	P 14.5 E	H1, 55 W
Fog light	PK 22 S	H 3, 55 W
Rear fog light	BA 15 S	P 21 W
Reversing light	BA 15 S	P 21 W
Combined brake and tail light	BAY 15 D	P 21/5 W
Direction indicator lights	BA 15 S	P 21 W
Carrera 4, Carrera 4S, Turbo: Direction indicator lights, front	BA 15S	PY 21 W (yellow)
Direction indicator lights, side	W 2.5 x 9.5 D	W 5 W
Side lights	BA 9 S	T 4 W
Interior lights	SV 8.5 - 8	K 10 W
Luggage compartment/ engine compartment light	SV 8.5 - 8	K 10 W
Number plate lights	SV 8.5 - 8	C 11 5 W

## Changing Bulbs

To avoid short circuits, switch off the equipment concerned when changing bulbs.

New bulbs must be free of dirt and grease. Handle them with a clean cloth or smooth paper.

For safety reasons you should always carry some spare bulbs in your car so that your Porsche is correctly lighted if any one of the bulbs should fail. It is also advisable to have a few spare bulbs when going abroad, as some countries insist on spare bulbs being carried in the car!

To clean the plastic bulb lenses, use soapy water only.

Do not clean with chemical cleaners.

All cables and control units of the Litronic dipped-beam headlight carry high tension; for this reason, extreme caution must be exercised.



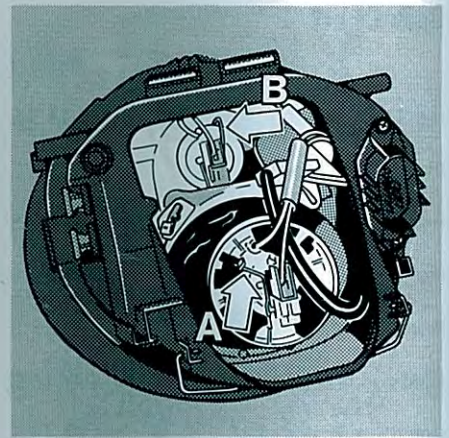
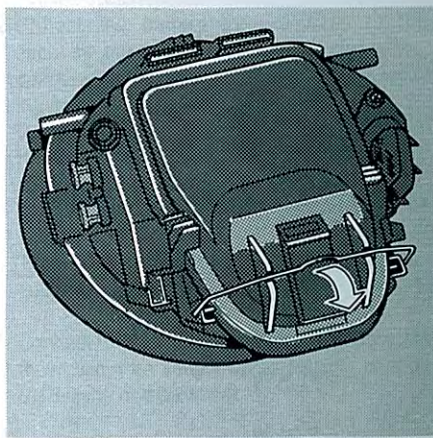
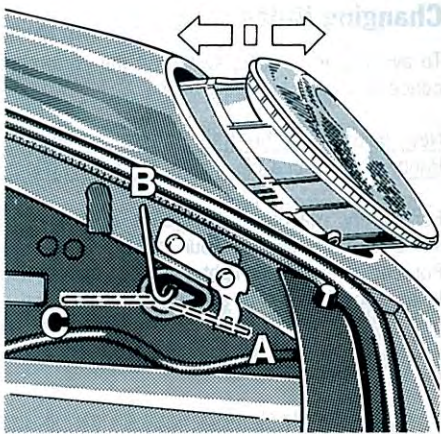

**Litronic dipped-beam headlight:**

If the Litronic dipped-beam headlight fails, contact an Official Porsche Centre or a Bosch Service.

All cables and control units of the Litronic dipped-beam headlight carry high tension; for this reason, extreme caution must be exercised.

**Headlights**

1. Detach side carpeting.  
Detach release lever from locking bar, move lever first to position C and then back to position B.  
Remove headlight unit.

2. Pivot bar on housing and remove cover.
3. Press down retaining catch on relevant bulb holder and push away to the side. Take out defective bulb and replace with a new one (ensure that it is snugly in place).
4. Press down retaining catch and move back sideways to engage.

A - Dipped-beam headlight  
B - High beam headlight

5. Place cover over headlight housing and fasten with the bar.
6. Place headlight into body panel and push in fully.  
Move release lever to position A and reattach to locking bar.  
Refasten carpeting.
7. Check operation and adjustment of headlights.



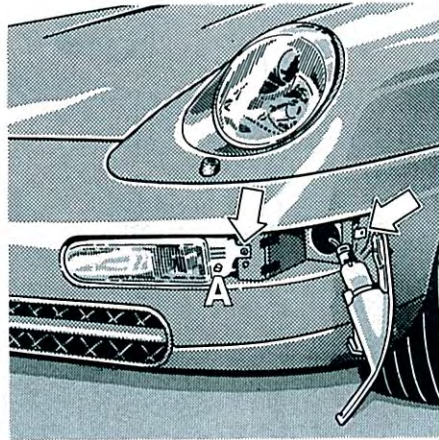
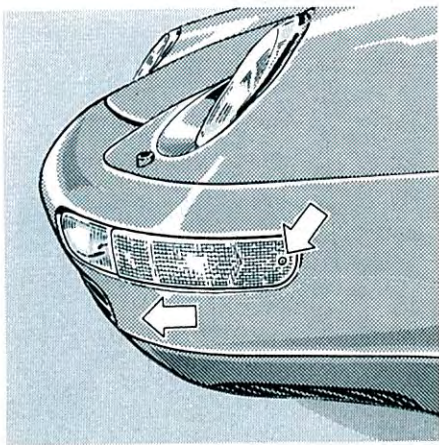

A - Fog lamp range adjustment

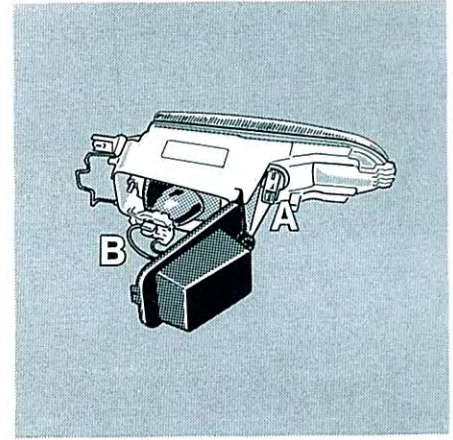

A - Side light  
B - Fog light

### Front Direction Indicator Lights

1. Remove screw on indicator housing and pull housing forward and out.
2. Twist bulb socket anticlockwise and pull out. Replace defective bulb (bayonet socket).
3. Insert bulb socket and twist clockwise.
4. Insert indicator housing and fasten with Phillips screws (be sure the screws seat properly).

5. Check that indicator operates.

### Fog Lights, Front Side Lights

1. Undo screw on indicator housing and pull socket out towards the front.
2. Undo screw on light unit housing (arrow) and take out to the side.

3. Side light (A):  
Squeeze bracket on plug together and disconnect plug. Unscrew bulb holder (bayonet mount). Replace bulb with a new one (bayonet mount).
4. Fog light (B):  
Disconnect plug. Slacken bracket on housing and remove cover. Detach retaining bracket on bulb holder, disconnect plug on lamp cable and replace bulb with a new one.



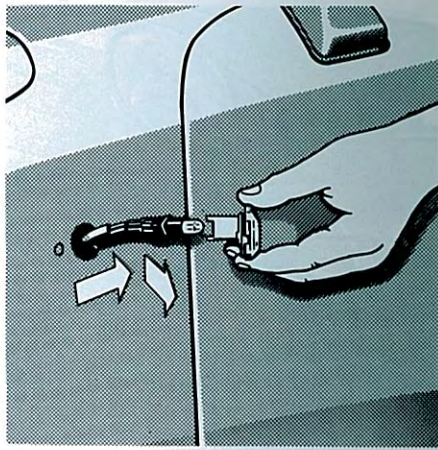

5. Fit on cover and secure with bracket. Reconnect both plugs on the housing. Insert light housing and secure.
6. Insert indicator light housing and secure.
7. Check operation of lights.

### Side Indicators

1. Slide light unit toward the rear of the vehicle and remove.
2. Pull the rubber sleeve and socket from the housing.
3. Remove the defective bulb and fit a replacement.

4. Reinsert the bulb socket, push the rubber sleeve into place and push the housing into its mounting in the wing until it snaps into place.

5. Check operation of the bulbs.



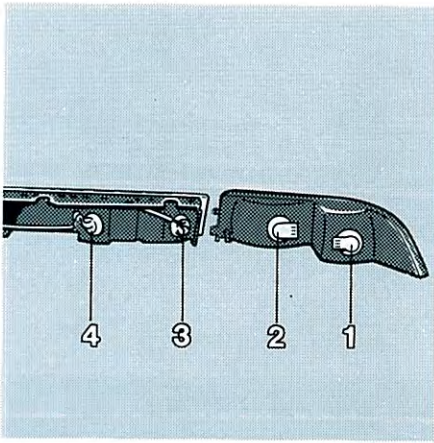

- 1 - Direction indicator light
- 2 - Combined brake and side light
- 3 - Reversing light
- 4 - Rear fog light

### Rear Direction Indicators, Brake Lights, Rear Side Lights

1. Unscrew Phillips screw in lens, and swing lens out.
2. Twist holder with defective bulb anticlockwise and remove bulb; replace defective bulb (bayonet mount).

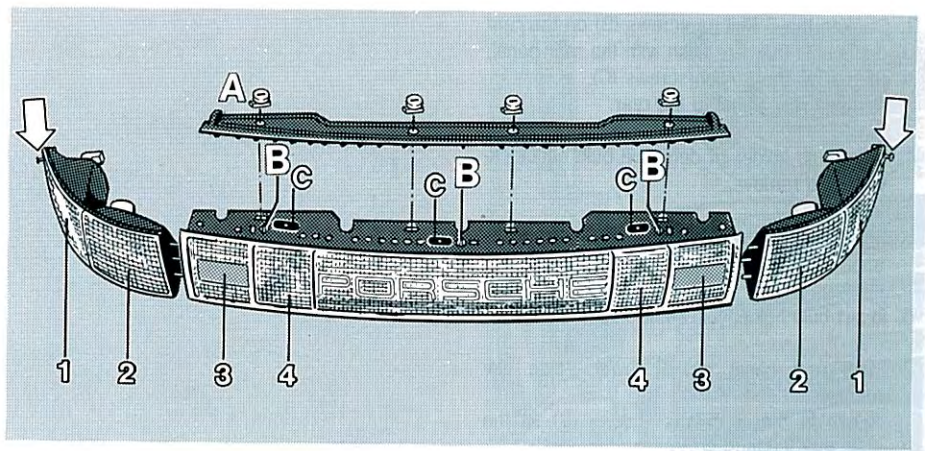

3. Insert bulb holder and twist clockwise.

4. Swing lens back into place and tighten Phillips screw (be sure the screw seats properly).

5. Check that bulb operates.

### Rear Fog Light and Reversing Light

1. Undo the screws on both indicator light units (arrows) and pull the light units sideways out of the rear panel

2. Turn the 4 screws (A) on the upper cover approx. 90° and remove cover.



3. Slacken the 3 Phillips screws (B) on the rear panel until they are flush with the rear panel, then undo the 3 Allen screws (C). Remove rear panel to the rear.
4. Twist bulb holder of defective bulb anticlockwise and remove.
5. Replace defective bulb with a new one (bayonet mount).
6. Insert bulb holder and twist clockwise.
7. Push rear panel into 3 lower guide elements.  
Screw in the 3 Phillips screws (B) all the way, then fasten the 3 Allen screws (C).
8. Place cover on rear panel and fasten with the 4 screws (approx. 90°).
9. Insert both indicator units and secure in place.
10. Check that bulbs operate.

### Raised brake light

If one of the bulbs blows, have it replaced at your Official Porsche Centre (these bulbs are soldered in place).

### Number Plate Light

1. Unscrew both screws and remove the cover.
2. Remove defective bulb from between contact springs and insert a new bulb.
3. Install cover, making sure that the rubber gasket is properly seated. Tighten screws and check that light operates.

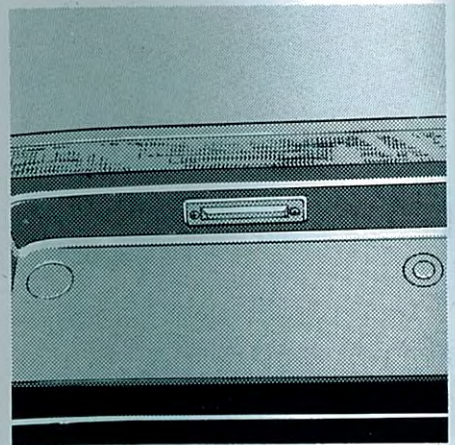



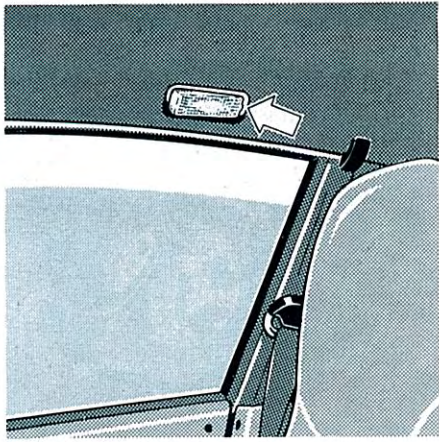

### Interior Lights

1. Carefully apply small screwdriver and push interior light unit out of lining (arrow).2. Take out defective bulb from between spring contacts and replace.
3. Insert light unit into cutout first from one side and then from the other side and press in. Check operation of light.

Interior light in the infra red module of the interior monitoring system:

If this bulb blows, have it replaced at your Official Porsche Centre.

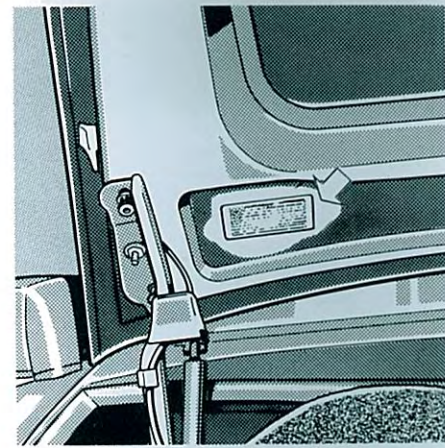

### Luggage Compartment Light

1. Carefully apply small screwdriver and push entire interior light unit out of lining (arrow).
2. Take out defective bulb from between spring contacts and replace.
3. Insert light unit into cutout first from one side and then from the other side and press in. Check operation of light.



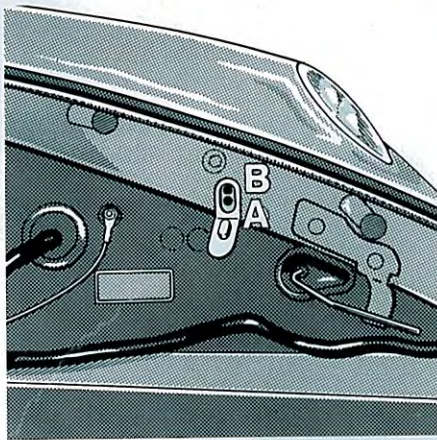

A - Vertical adjustment  
B - Lateral adjustment

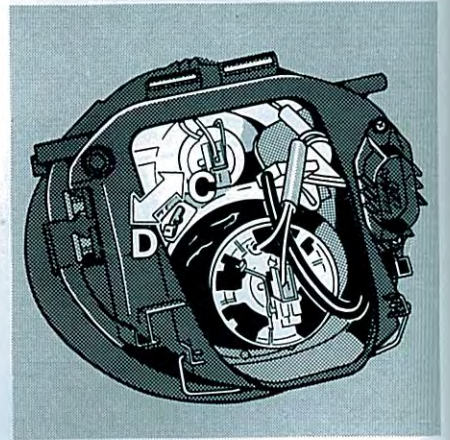

C - Countries with traffic on left  
D - Countries with traffic on right

## Adjusting Headlights

The basic adjustment of the headlights can only be performed on a special machine. It should be carried out with the vehicle in ready-to-drive condition and with the fuel tank full. The driver's seat must be occupied by a person or a 75 kg weight, and the tyres must be inflated to the specified pressures. With the vehicle in this condition, it should then be rolled a few metres to allow the suspension springs to settle.

Cars without Litronic headlights: The headlight beam adjustment must be in position "0".

### Adjustment screws

The adjustment screws are accessible from the luggage compartment. Detach the carpeting at the side and open the cover on the adjustment screws.

Each headlight is equipped with separate adjustment screws for vertical and lateral adjustment of the reflector. Turning the screws clockwise or anticlockwise will change the aiming accordingly.

### Adjusting the headlights to countries where traffic drives on the other side of the road

If you are entering a country in which the traffic drives on the left, the headlight reflectors must be adjusted when you cross the border. This makes the dipped beam headlight aiming symmetrical, so that you do not dazzle the drivers of oncoming vehicles.

To adjust the reflectors:

1. Take out headlight unit (refer to section on "Headlights") and remove housing cover.



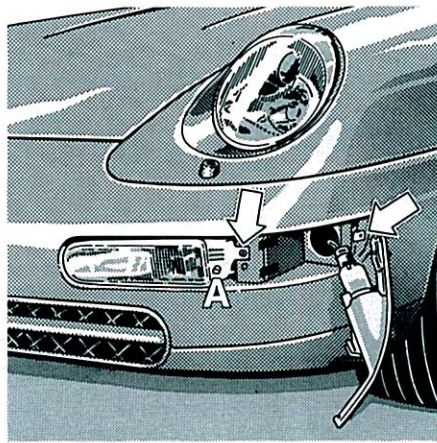

A - Vertical adjustment of fog lights

2. Move slide to position C and allow to engage.
3. Close cover on housing and reinstall headlight.

Remember to restore the headlights to their original setting on your return journey.

### **Adjusting Fog Lights**

The fog lights are adjusted by turning the adjustment screw (A).



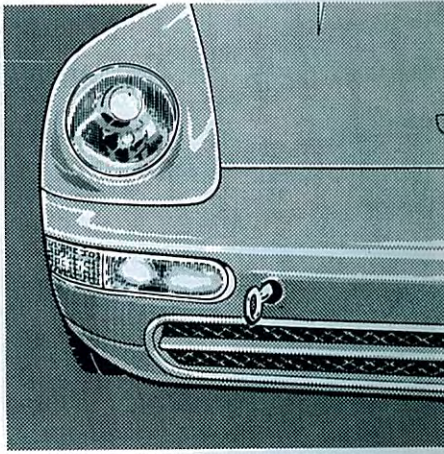
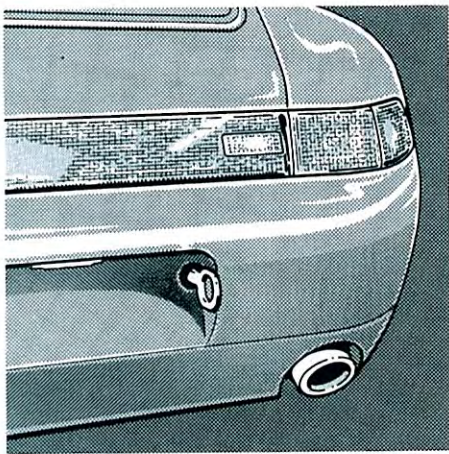

## Towing

The towing eye can be found in the tool kit.

To tow another vehicle, remove the plastic plug in the rear bumper and screw in the towing eye.

If your Porsche has to be towed, screw the towing eye into the hole beside the number plate at the front of the vehicle. To do this, remove the plastic cap carefully with the screw driver.

Always observe the applicable laws governing towing.

When you tow another vehicle, it must not be heavier than your Porsche.

During towing, always keep the tow rope taut, but avoid sudden jerks on the rope. The vehicle being towed should have the ignition turned on so that the brake and direction indicator lights function, and that the steering lock is released.

Please note the instructions in the chapter "Tiptronic".

Remember, when the engine is not running, that no servo assistance is given, and more force is required for braking and steering.

Carrera 4, Carrera 4S, Turbo:

When the vehicle is to be towed with the front or rear axle off the ground, the wheels of the raised axle must be able to rotate freely.

## Tow Starting

If the battery is defective or completely flat, the engine can only be started by replacing the battery or using jump leads.

Vehicles with catalytic converters may only be tow-started when the engine is cold.

Vehicles with "Tiptronic" cannot be tow-started.



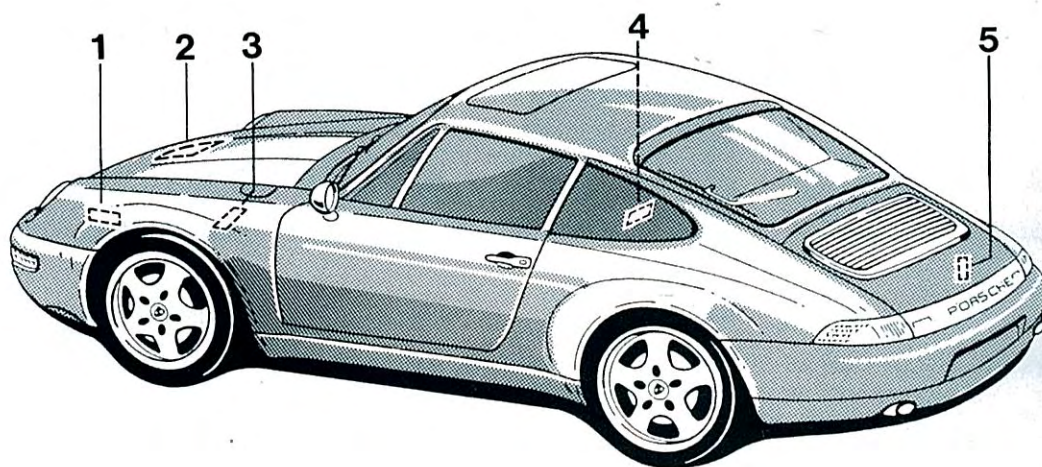

- 1 Paint data
- 2 Data bank
- 3 Vehicle identification number
- 4 Identification plate
- 5 Engine number

## Vehicle Identification

When ordering spare parts or submitting enquiries, always quote vehicle identification and engine numbers to ensure correct and prompt service.

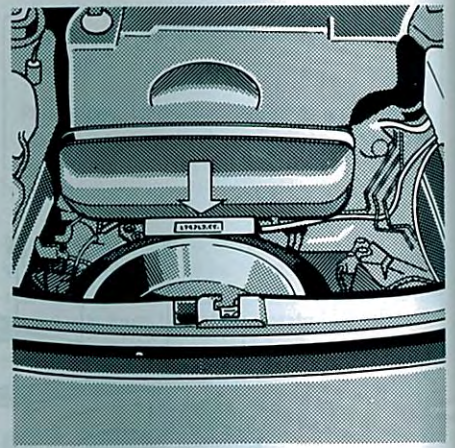
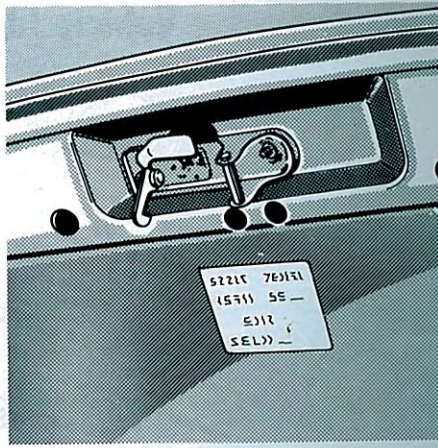

### Data bank

The data bank is affixed to the inside of the luggage compartment lid beneath the lid lock. The data bank contains all the important data for your car.

### Vehicle identification number

You will find the vehicle identification number stamped in the luggage compartment under the carpet and at the bottom left of the windscreen frame.



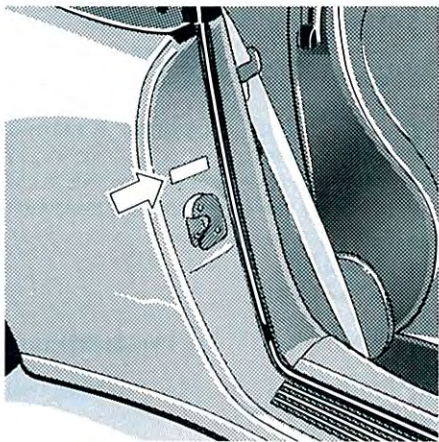

#### **Identification plate**

The identification plate is attached to the lock pillar of the right door.

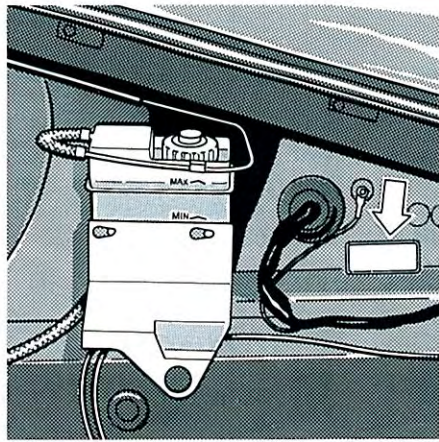

#### **Paint data**

The paint data plate is affixed to the inside of the left side panel of the luggage compartment, underneath the carpet.

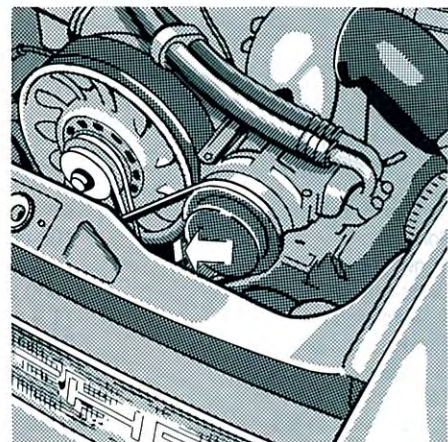

#### **Engine number**

The engine number is stamped on the right-hand fan housing support.

## Engine data

	<b>Carrera</b>	<u>Increased performance version</u>	<b>Turbo</b>	<u>Increased performance version</u>
Engine type with Tiptronic	M 64/21 M 64/22	M 64/21S M 64/22S	M 64/60	M 64/60R
Number of cylinders	6		6	
Bore	100 mm (3.94 in.)	102 mm (4.02 in.)	100 mm (3.94 in.)	
Stroke	76.4 mm (3.01 in.)		76.4 mm (3.01 in.)	
Cubic capacity	3600 cm <sup>3</sup> (219.7 cu in.)	3746 cm <sup>3</sup> (228.6 cu in.)	3600 cm <sup>3</sup> (219.7 cu in.)	
Compression ratio	11.3 : 1		8.0 : 1	
Engine output per EEC at crankshaft speed	210 kW (285 HP) 6100 rpm	221 kW (300 HP) 6500 rpm	300 kW (408 HP) 5750 rpm	316 kW (430 HP)
Torque per EEC at crankshaft speed	340 Nm 5250 rpm	355 Nm 5400 rpm	540 Nm 4500 rpm	
Specific output	58.3 kW/l (79.2 HP/l)		83.3 kW/l (113.3 HP/l)	
Engine oil consumption	up to 1.5 l/1000 km		up to 1.5 l/1000 km	
Maximum rpm	6700 rpm		6700 rpm	
Spark plugs	Bosch FR 6 LDC, FR 5 DTC, Beru 14 FR 5 DTU, 14 FR 6 LDU		Bosch FR 6 LDC Beru 14 FR 6 LDU	
Spark-plug gap	0.7 + 0.1 mm (0.026 + 0.004 in.)		0.7 + 0.1 mm (0.026 + 0.004 in.)	
Alternator	Three-phase 1610/115 A		Three-phase 1610/115 A	
Firing order	1 - 6 - 2 - 4 - 3 - 5		1 - 6 - 2 - 4 - 3 - 5	
Ignition system	Electronic, dual ignition, knock control		Electronic, single ignition, knock control	
Valve clearance compensation	Hydraulic		Hydraulic	
<u>Drive belts</u>				
Fan	9.5 x 776 La		9.5 x 760 La	
Alternator	9.5 x 776 La		9.5 x 769 La	
Manual transmission	9.5 x 760 La			
Tiptronic	13 x 1085 La			
Air Conditioning System			13 x 1085 La	

Only use Original Porsche-approved belts.



## Power Transmission

### Carrera, Carrera S:

Rear-mounted engine and gearbox bolted together to form single drive unit. Drive to rear wheels via dual articulated shafts.

### Carrera 4, Carrera 4S, Turbo:

Engine and gearbox are bolted together in the rear end. Together with a transaxle, they form a single drive unit between rear wheel and front wheel drive. Torsionally elastic drive shaft, mounted in transaxle between front and rear axle transmission. Permanent four-wheel drive with variable torque distribution via viscous multi-disc clutch. Load-dependent limited-slip differential.

## Transmission

Gear ratios:

	Carrera	Tiptronic S	Turbo
1st gear	3.82 : 1	2.73 : 1	3.82 : 1
2nd gear	2.05 : 1	1.63 : 1	2.15 : 1
3rd gear	1.41 : 1	1.10 : 1	1.56 : 1
4th gear	1.12 : 1	0.80 : 1	1.21 : 1
5th gear	0.93 : 1		0.97 : 1
6th gear	0.78 : 1		0.75 : 1
Reverse	2.86 : 1	2.29 : 1	2.86 : 1
Final drive ratio	3.44 : 1	3.67 : 1	3.44 : 1

**Driving Performance\***

	<b>Carrera</b>	<b>Carrera S</b>	<b>Carrera 4</b>
Top speed	275 km/h (171 mph)	270 km/h (168 mph)	275 km/h (171 mph)
Acceleration 0 – 100 km/h	5.4 seconds	5.4 seconds	5.3 seconds
Standing-start kilometer	24.6 seconds	24.8 seconds	24.8 seconds

	<b>Carrera Tiptronic S</b>	<b>Carrera S Tiptronic S</b>	<b>Carrera 4S</b>
Top speed	270 km/h (168 mph)	265 km/h (165 mph)	270 km/h (168 mph)
Acceleration 0 – 100 km/h	6.4 seconds	6.4 seconds	5.3 seconds
Standing-start kilometer	25.4 seconds	25.6 seconds	25.0 seconds

	<b>Turbo</b>
Top speed	290 km/h (180 mph)
Acceleration 0 – 100 km/h	4.5 seconds
Standing-start kilometer	23.0 seconds

\* At DIN empty weight and half load, without performance-inhibiting extra equipment (e. g. air conditioning, special tyres)

the approved belts.



## Fuel Consumption

Determined in accordance with the new Directive 93/116/EC, applicable to all chassis versions

	Engine type	Transmission type	Urban (l/100 km)	Nonurban (l/100 km)	Total (l/100 km)	Target figure CO <sub>2</sub> (g/km)
Carrera 2	M 64/21	M 6	17.6	8.6	11.9	295
Carrera 2	M 64/21S	M 6	20.2	9.4	13.4	322
Carrera 2 Tiptronic	M 64/22	Automatic	18.2	8.7	12.2	303
Carrera 2 Tiptronic	M 64/22S	Automatic	21.7	9.4	13.9	329
Carrera S	M 64/21	M 6	17.7	8.8	12.0	296
Carrera S	M 64/21S	M 6	20.5	9.5	13.5	329
Carrera S Tiptronic	M 64/22	Automatic	18.5	8.7	12.4	307
Carrera 4	M 64/21	M 6-4WD	17.9	8.9	12.2	299
Carrera 4	M 64/21S	M 6-4WD	20.6	9.6	13.6	332
Carrera 4S	M 64/21	M 6-4WD	18.0	9.1	12.3	301
Carrera 4S	M 64/21S	M 6-4WD	20.7	9.8	13.8	339
Turbo	M 64/60	M 6-4WD	23.5	11.2	15.7	376
Turbo	M 64/60R	M 6-4WD	23.5	11.2	15.7	376
GT2	M 64/60R	M 6	23.3	10.8	15.4	368

## Tyres, Rims, Tracks

		Tyres	Rims	Rim offset	Track
<b>Carrera, Carrera 4</b>					
<b>Summer tyres</b>	front	205/55 ZR 16	7 J x 16 H2	55 mm	1405 mm
	rear	245/45 ZR 16	9 J x 16 H2	70 mm	1444 mm
Alternatively	front	205/50 ZR 17	7 J x 17 H2	55 mm	1405 mm
	rear	255/40 ZR 17	9 J x 17 H2	55 mm	1474 mm
Alternatively <u>Coupé/Cabriolet only</u>	front	225/40 ZR 18	8 J x 18 H2	52 mm	1411 mm
	rear	265/35 ZR 18	10 J x 18 H2	65 mm	1454 mm
<b>Winter tyres</b>	front	205/55 R 16 89 T M+S	7 J x 16 H2	55 mm	1405 mm
	rear *	225/50 R 16 92 T M+S	8 J x 16 H2	70 mm	1444 mm
Alternatively	front	205/50 R 17 89 T M+S	7 J x 17 H2	55 mm	1405 mm
	rear *	225/45 R 17 90 T M+S	8 J x 17 H2	70 mm	1444 mm
<b>Carrera S</b>					
<b>Summer tyres</b>	front	205/50 ZR 17	7 J x 17 H2	55 mm	1405 mm
	rear **	255/40 ZR 17	9 J x 17 H2	55 mm	1536 mm
Alternatively	front	225/40 ZR 18	8 J x 18 H2	52 mm	1411 mm
	rear	285/30 ZR 18	10 J x 18 H2	40 mm	1504 mm
<b>Winter tyres</b>	front	205/50 R 17 89 T M+S	7 J x 17 H2	55 mm	1405 mm
	rear *	225/45 R 17 90 T M+S	8 J x 17 H2	30 mm	1524 mm

\* Allowing snow chain clearance.

\*\* This tyre and rim combination can be used only in conjunction with Original Porsche spacer discs (31 mm).  
Unscrew and remove the spacer discs if fitting other combinations of rims and tyres and in order to fit spare tyre.



**Tyres, Rims, Tracks**

		Tyres	Rims	Rim offset	Track
<b>Carrera 4S, Turbo</b>					
<b>Summer tyres</b>	front	225/40 ZR 18	8 J x 18 H2	52 mm	1411 mm
	rear	285/30 ZR 18	10 J x 18 H2	40 mm	1504 mm
<b>Winter tyres</b>	front	205/50 R 17 89 T M+S	7 J x 17 H2	55 mm	1405 mm
	rear	* 225/45 R 17 90 T M+S	8 J x 17 H2	30 mm	1524 mm

The load capacity coefficient (e.g. 90) and maximum speed code letter (e.g. T) are minimum requirements. When fitting new tyres or changing tyres, please observe notes given in the section headed "Tyres and Tyre Care".

**Tyre and rim sizes** The authorization of tyre and rim sizes is granted on the basis of extensive testing. Your Official Porsche Centre will gladly give you any information on the authorization status. Refitting with sizes not authorized by Porsche may have a dangerous effect of the driving stability.

**Snow chains** Chains can be mounted only on the rear wheels; maximum speed 50 km/h. Use only Porsche-authorized snow chains. Snow chain clearance can be guaranteed only on the tyre + rim combination marked \*.

**Spare wheel** 165/70 -16 92 P collapsible tyre on 5 1/2 J x 16 rim, rim offset 30 mm. Maximum speed 80 km/h.

## Tyre Pressures

Tyres cold, in bar overpressure (psi)

### Summer tyres

		Carrera	Turbo
Front	16" wheels	2.5 (36)	
	17" wheels	2.5 (36)	
	18" wheels	2.5 (36)	2.5 (36)
Rear	16" wheels	3.0 (44)	
	17" wheels	2.5 (36)	
	18" wheels	3.0 (44)	3.0 (44)

### Winter tyres

Front	16" wheels	2.5 (36)	
	17" wheels	2.5 (36)	2.5 (36)
Rear	16" wheels	3.0 (44)	
	17" wheels	2.5 (36)	3.0 (44)

### Collapsible spare tyre

Front and rear	2.5 (36)	2.5 (36)
----------------	----------	----------

These pressures only apply for tyre makes and types approved by Porsche.  
It is absolutely essential to comply with the instructions in the section "Tyres and Tyre Care".



## Capacities

Engine	Oil change quantity without oil filter: approx. 8 liters Oil change quantity with oil filter: approx. 9.5 liters Reference indication is the level on the oil dipstick. Refer to the section entitled "Checking the oil level" <u>Only use oils tested and recommended by Porsche.</u> Your Official Porsche Centre will gladly advise you. See section "Engine Oils".
Manual transmission and differential	<u>Carrera, Carrera S</u> : approx. 3.6 liters <u>Carrera 4, Carrera 4S</u> : approx. 3.8 liters <u>Turbo</u> : approx. 4.3 liters SAE 75 W 90 gear oil, API classification GL 5 (or Mi-L 2105 B)
Front-axle differential	<u>Carrera 4, Carrera 4S, Turbo</u> : approx. 0.6 liters SAE 75 W 90 gear oil, API classification GL 5 (or Mi-L 2105 B)
Tiptronic S	approx. 9.5 liters ATF-Dexron II D
Differential with Tiptronic S	approx. 0.9 liters SAE 75 W 90 gear oil, API classification GL 5 (or Mi-L 2105 B)
Fuel tank	re-fill volume approx. 72 liters, including approx. 10 liters reserve (Turbo approx. 15 liters) or approx. 92 liters, including approx. 10 liters reserve (Turbo approx. 12 liters)
Fuel quality	The engine is designed to provide optimum performance and fuel consumption if <u>unleaded premium fuel, minimum 98 RON / 88 MON</u> is used. If unleaded premium fuels with octane numbers of <u>at least 95 RON / 85 MON</u> are used, the engine's knock control system automatically adapts the ignition timing.
Power steering	<u>Carrera, Carrera S, Carrera 4, Carrera 4S</u> : approx. 1.0 liters hydraulic fluid Pentosin CHF 11 S
Power steering, hydraulic clutch	<u>Turbo</u> : approx. 1.7 liters hydraulic fluid Pentosin CHF 11 S
Brake fluid reservoir	<u>Carrera, Carrera S</u> : approx. 1 liter <u>Carrera 4, Carrera 4S, Turbo</u> : approx. 1.4 liters, only Original Porsche brake fluid
Windshield washer	approx. 7.0 liters

Your Porsche is designed so that it is not necessary to add additives to the oils and fuels used.

**Weights**

	<b>Carrera</b>	<b>Carrera Tiptronic S</b>	<b>Carrera S</b>	<b>Carrera S Tiptronic S</b>	<b>Carrera 4</b>
Empty weight per DIN	1370 kg	1395 kg	1400 kg	1425 kg	1420 kg
Empty weight per 70/156/EEC*	1445 kg	1470 kg	1475 kg	1500 kg	1495 kg
Maximum gross weight	1710 kg	1735 kg	1740 kg	1765 kg	1760 kg
Maximum axle load, front**	720 kg	720 kg	720 kg	720 kg	760 kg
Maximum axle load, rear**	1080 kg	1080 kg	1080 kg	1080 kg	1070 kg
Maximum roof load*** Coupé	75 kg	75 kg	75 kg	75 kg	75 kg

	<b>Carrera 4S</b>	<b>Targa</b>	<b>Targa Tiptronic S</b>	<b>Turbo</b>
Empty weight per DIN	1450 kg	1400 kg	1425 kg	1500 kg
Empty weight per 70/156/EEC*	1525 kg	1475 kg	1500 kg	1575 kg
Maximum gross weight	1790 kg	1740 kg	1765 kg	1840 kg
Maximum axle load, front**	760 kg	720 kg	720 kg	760 kg
Maximum axle load, rear**	1070 kg	1080 kg	1080 kg	1150 kg
Maximum roof load*** Coupé, Targa	75 kg	75 kg	75 kg	75 kg

\* Empty weight incl. 75 kg (driver and baggage share)

\*\* Note: If additional accessories are installed (air conditioner, etc.) the usable load will be correspondingly less.

\*\*\* Applies only when original Porsche Transport System is used, otherwise roof load is 35 kg.



Dimensions (at DIN empty weight)

		<b>Carrera Carrera 4</b>	Sports chassis	Standard chassis lowered
Length		4245 mm		
Width		1735 mm		
Height		1300 mm	1285 mm	1285 mm
Wheelbase		2272 mm		
Turning circle		11.74 m		
Overhang angle	front *	10.5°	10.0°	10.0°
	rear	12.5°	11.5°	11.0°
Ramp angle *		13.0°	12.0°	11.5°
Ground clearance *		110 mm	100 mm	95 mm

		<b>Carrera 4S Carrera S</b>	Sports chassis	Sports chassis lowered	<b>Turbo</b>
Length		4245 mm			4245 mm
Width		1795 mm			1795 mm
Height		1285 mm	1285 mm	1285 mm	1285 mm
Wheelbase		2272 mm			2272 mm
Turning circle		11.74 m			11.74 m
Overhang angle	front *	10.0°	10.0°	10.0°	10.0°
	rear	10.0°	10.5°	11.0°	10.5°
Ramp angle *		12.0°	12.5°	11.5°	12.5°
Ground clearance *		95 mm	95 mm	95 mm	100 mm

\*at maximum gross weight

## Diagrams

### Acceleration diagram:

Values have been determined at DIN empty weight and with a 50 % load without additional equipment.

### Transmission diagram:

The transmission diagram is based on standard values on the basis of a mean effective scrub radius.

Changes of the scrub radius, the tyre tolerance, wear and tear, deviating country equipment and tyre slip have not been taken into account.

## Full-Power Curves 911 Carrera

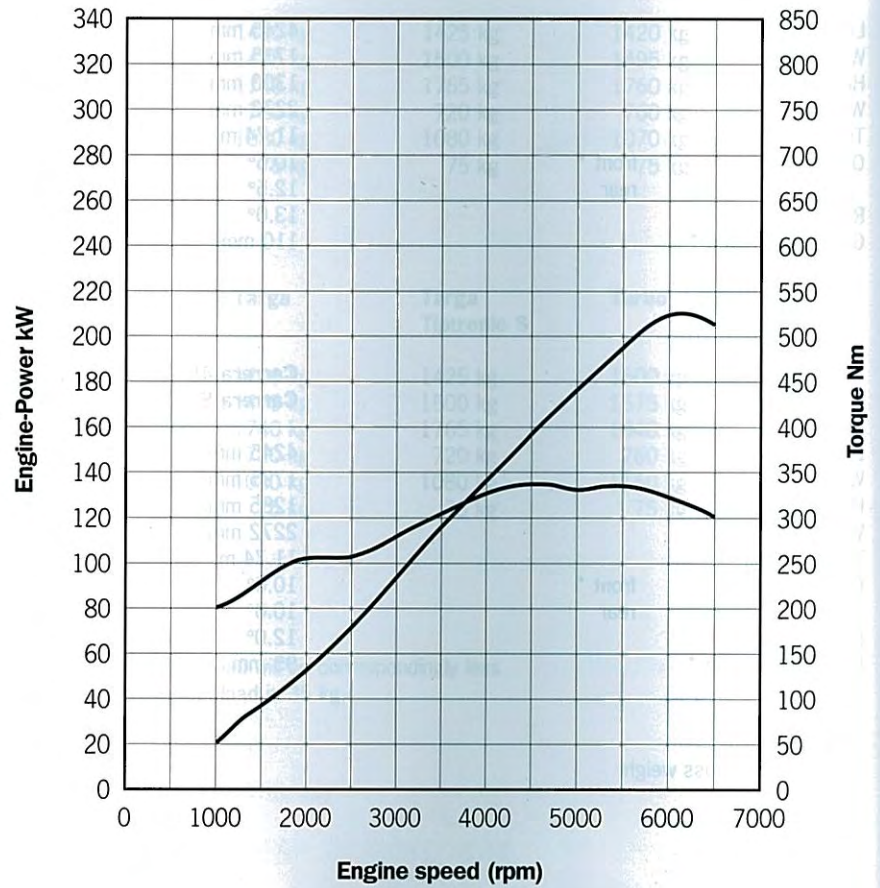



### Full-Power Curves 911 Turbo

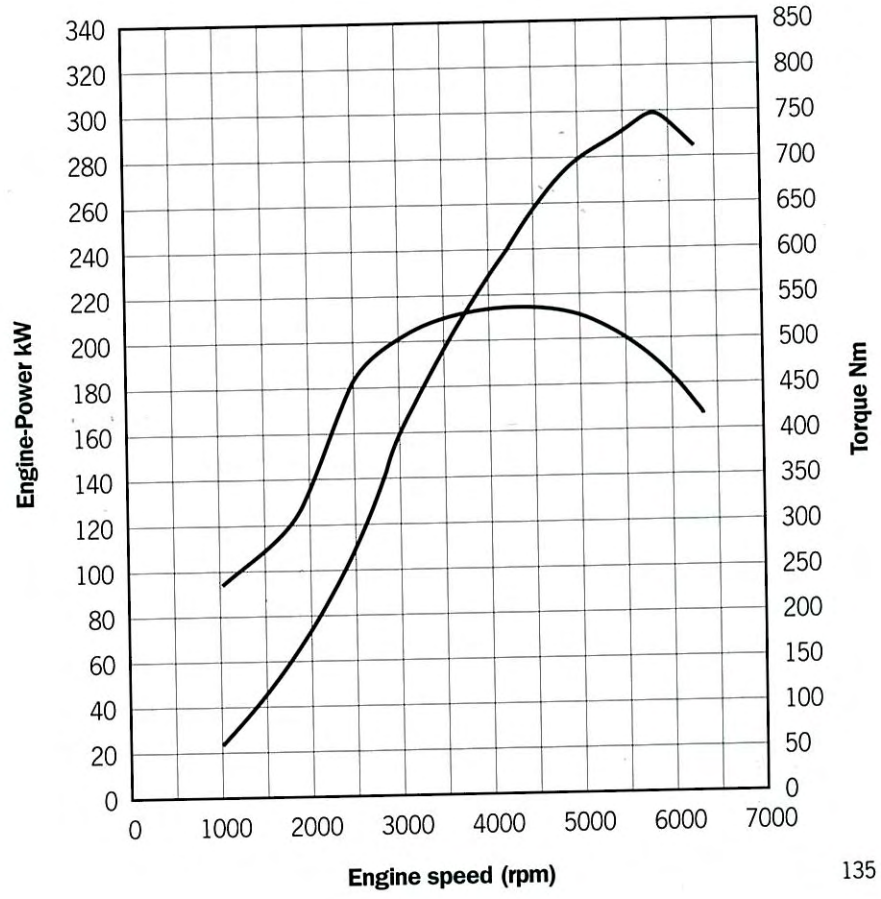

# Acceleration Curve 911 Carrera

Manual Gearbox

Full Power Curves 911 Carrera

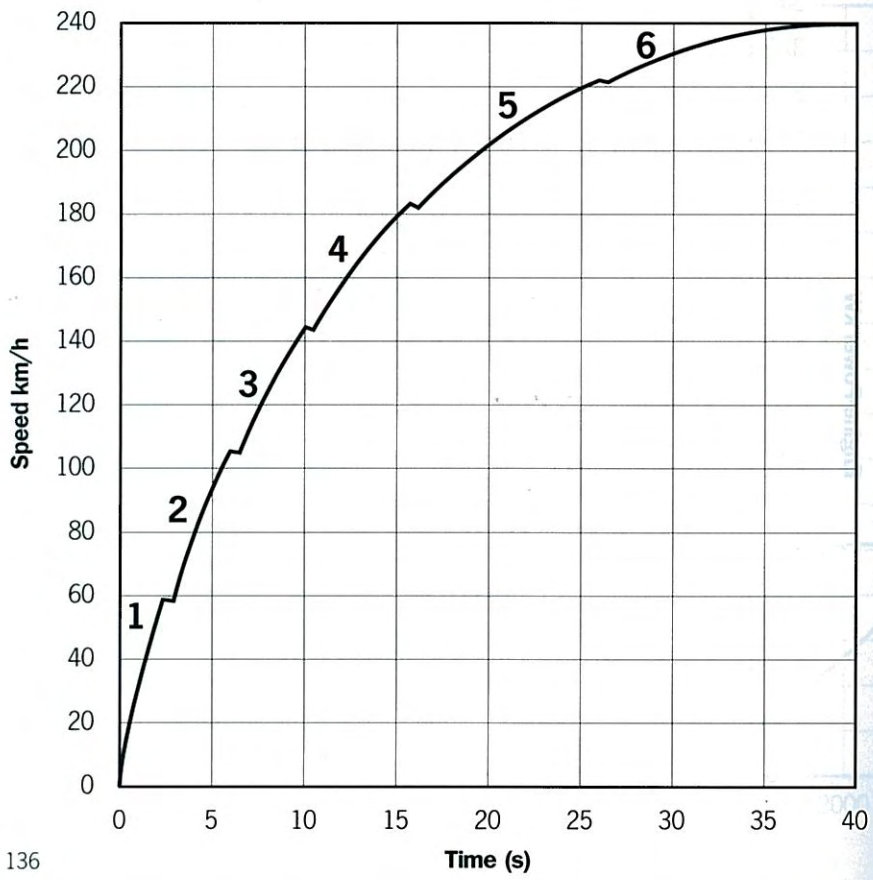

RESEARCH ENGINEERING

Engine speed (rpm)



# Acceleration Curve 911 Turbo

Manual Gearbox

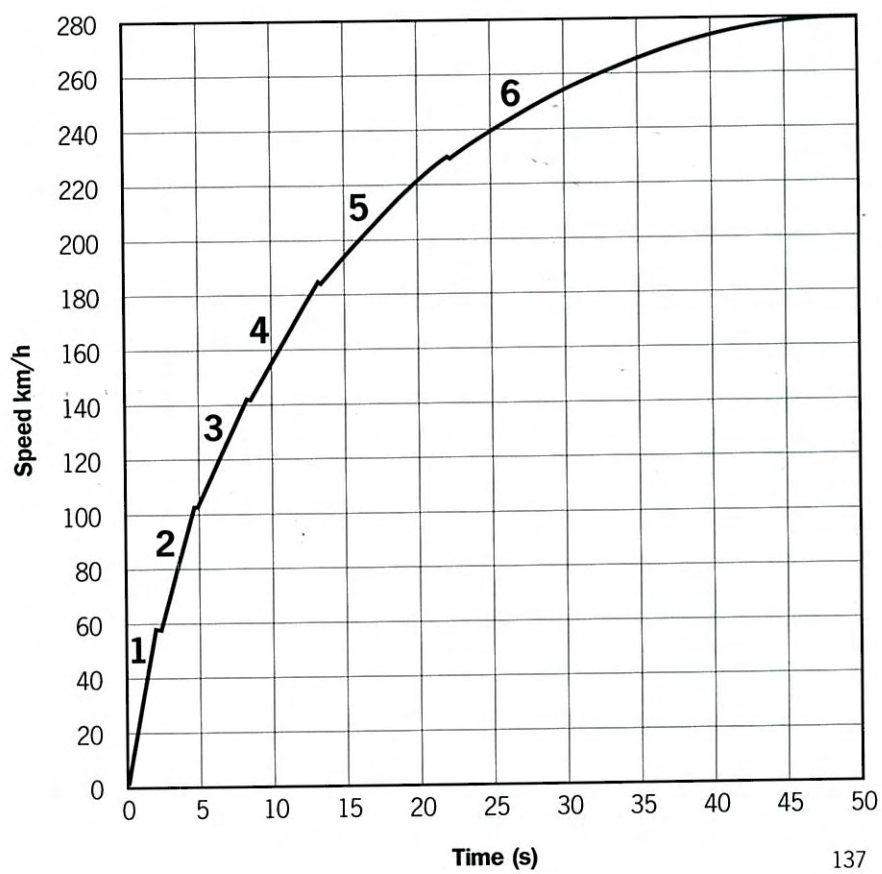

# Transmission Diagram 911 Carrera

Manual Gearbox

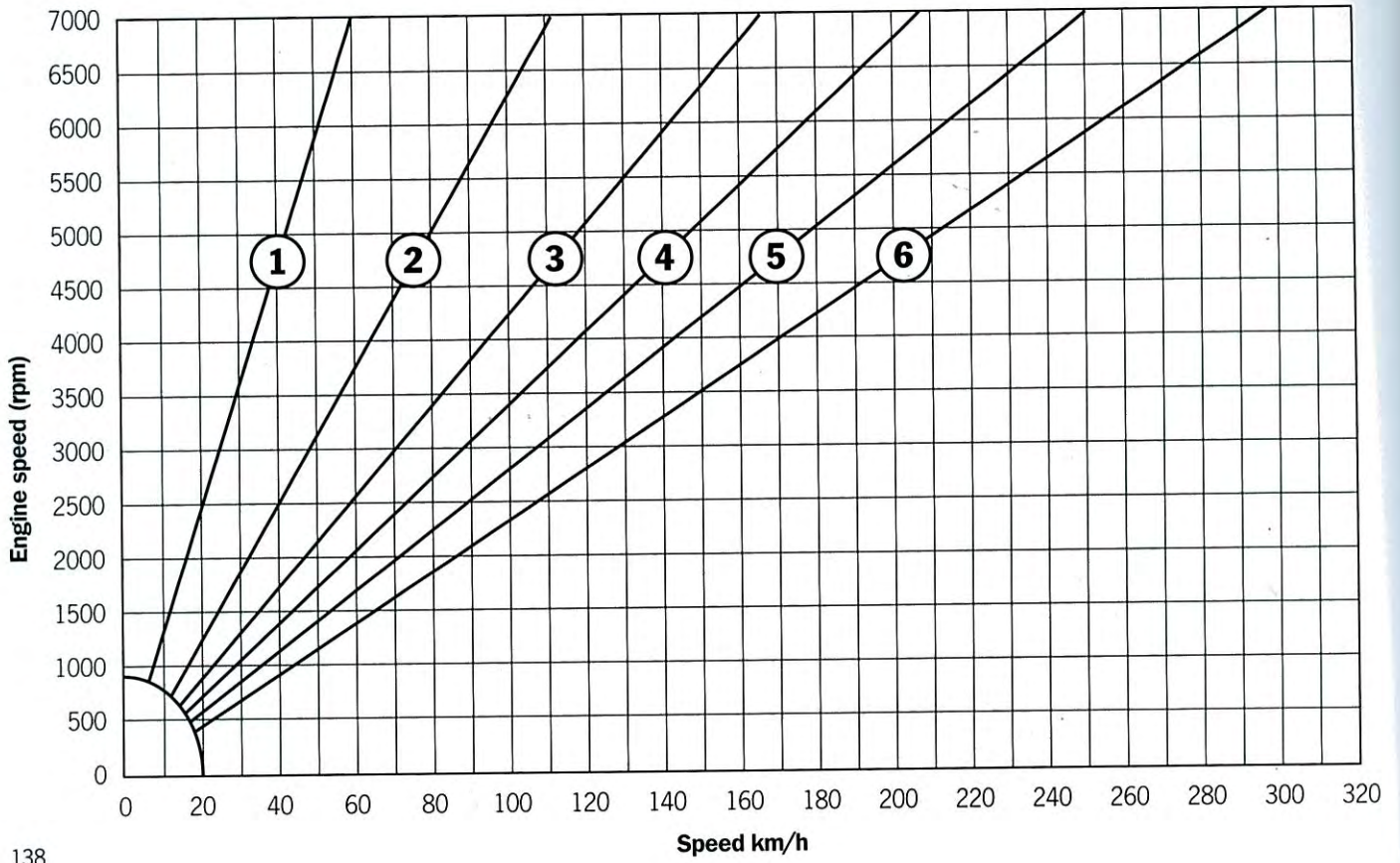



# Transmission Diagram 911 Carrera

Tiptronic

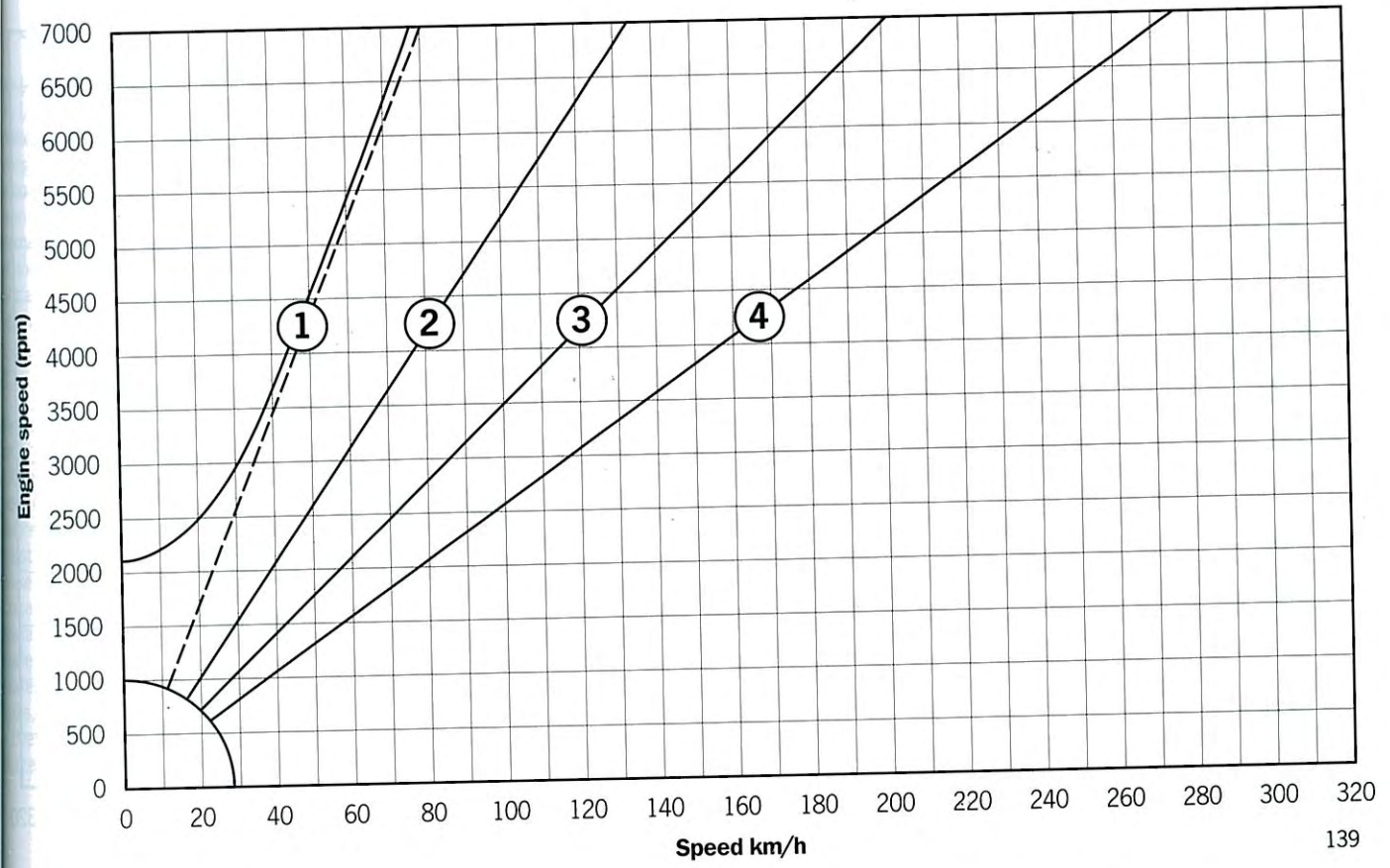

# Transmission Diagram 911 Turbo

Manual Gearbox

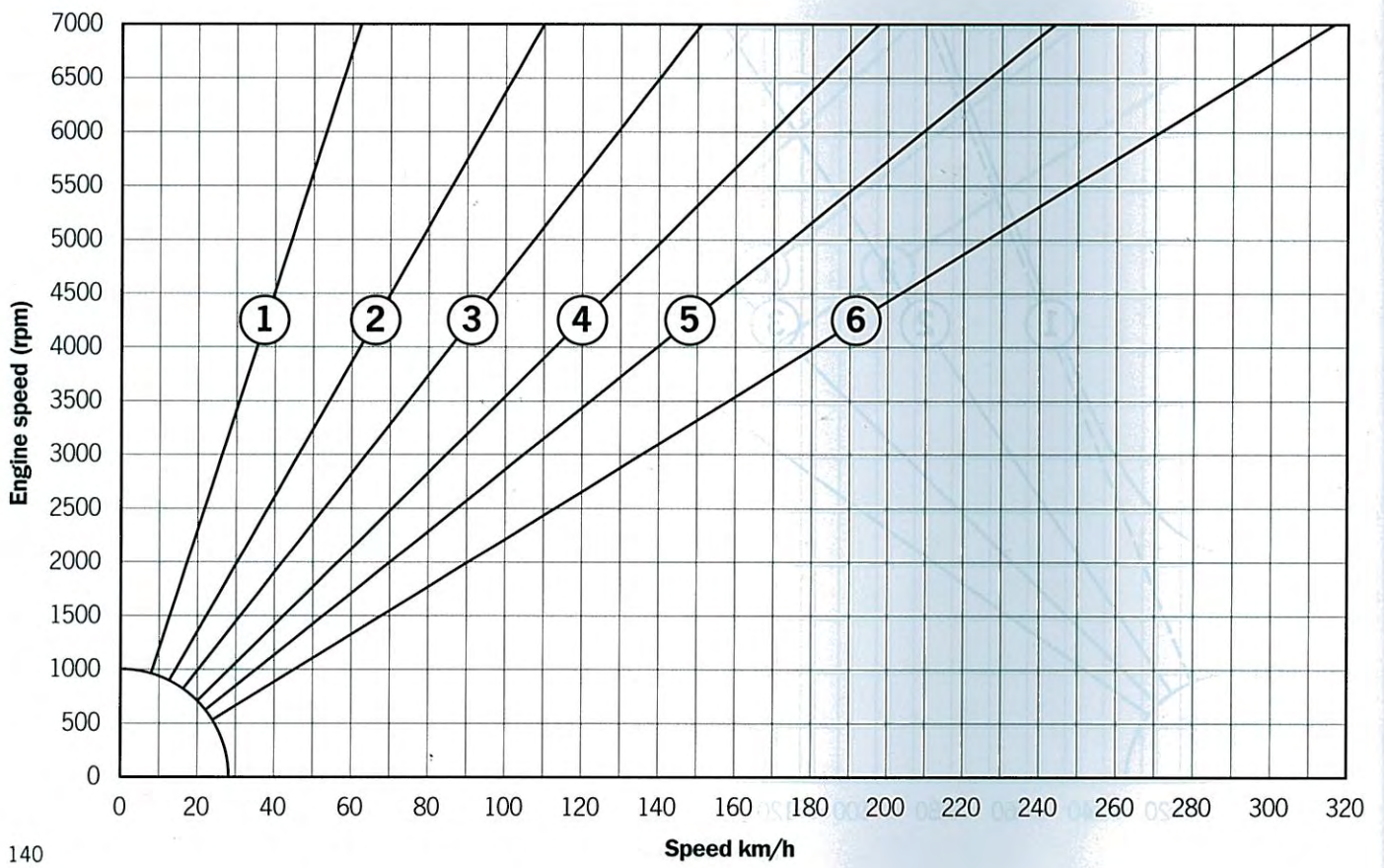



**F**

Fan belt monitor light .....	47
First aid kit .....	98
Fog lights .....	54
Folding top indicator light .....	47
Footbrake .....	28
Four-wheel drive .....	31, 32
Front lid .....	67
Fuel .....	4, 86
– Consumption .....	127
Fuel can .....	86
Fuel tank .....	86
Fuel gauge .....	41
Fuel tank filler flap .....	86
Fuel tank filler neck .....	86
Fuel tank ventilation system .....	87
Fuses .....	106

**G**

Gearchanging .....	61 – 66
Glove compartment .....	56

**H**

Handbrake .....	28, 43
Hazard warning lights .....	55
Headlight beam adjustment .....	50
Headlight flasher .....	51
Headlights .....	50, 54, 112 – 119
– Adjustment .....	118, 119
– Cleaning system .....	52, 131
Heated seats .....	23
Heat regulation system .....	58 – 60
High beam pilot light .....	44
Horn .....	34

**I**

Identification plate .....	123
Ignition lock .....	36, 62
Immobilizer .....	14 – 16, 47
Indicator .....	34
Indicator, high/dipped beam, parking light, headlight flasher stalk .....	51
Indicator pilot light .....	44
Inside rear-view mirror .....	21
Instruments .....	34 – 49
– Illumination .....	50
Interior lights .....	19, 20
– Mirror .....	21
Intermittent wiper switch .....	52

**J**

Jack .....	98, 104, 105
Jump lead starting .....	110

**K**

Keys .....	10 – 12
– Key card .....	10
Leather .....	92

**L**

Lid locks .....	67, 68
Light switch .....	50
Luggage compartment .....	67
Lumbar support .....	23

**N**

Number plate light .....	116
--------------------------	-----

**M**

Maintenance .....	79 – 94
Manual transmitter .....	14 – 18
– Battery replacement .....	11
– Tuning-in .....	15
Maximum rpm .....	8, 61, 64, 124
Maximum rpm for gearchange .....	61, 64
Minor repairs .....	97 – 120
Mirrors .....	21, 57

Checking oil level .....	41, 81
Dipstick .....	81, 131
Grades .....	82, 131
Pressure .....	42
Pressure gauge .....	42
Refilling .....	81
Thermometer .....	33, 42
In-board computer .....	48, 49
Paint care .....	88 - 92
Paint data .....	123
Parking lights .....	51
Particle filter .....	60
Passenger compartment monitoring .....	19
Performance data .....	122, 123
Power-assisted steering .....	83, 84, 131
Power windows .....	13
Practical tips .....	97 - 120

## R

Radio reception .....	95
Rear lid .....	68
Rear seat backs .....	23
Rear spoiler .....	33
- Warning light .....	46
Rear-view mirrors .....	21, 54
Rear window wiper .....	55
Rear window, heated .....	54
Recirculating air switch .....	59
Relay .....	106
Release handle for compartment lid .....	68
Remote control .....	14 - 18
Rims .....	128, 129
Roof load .....	94, 132
Roof rack .....	94, 132
Running in .....	8

## S

Seat belts .....	24, 25, 46, 92
Seat heating .....	23
Seats .....	22, 23
Security wheel nuts .....	103
Selector lever position indicator .....	45, 62
Side light pilot light .....	47
Ski rack .....	94, 131
Snow chains .....	93, 94, 128, 129
Sound control .....	95
Spare wheel .....	102, 128 - 130
Spark plugs .....	124
Speedometer .....	45, 48, 49
Spoiler .....	33, 36
- Warning light .....	46
Starting and stopping the engine .....	35, 36
Steering and ignition lock .....	36, 62
Sun visors .....	57
Sun roof .....	69



<b>T</b>		<b>U</b>		<b>W</b>	
Tachometer .....	45, 48, 49	Undersealing .....	87, 91	Warning buzzer .....	50, 51
Targa .....	70 - 72			Warning triangle .....	98
Technical data .....	124 - 140	<b>V</b>		Washer fluid .....	41, 86, 93, 131
Telephone .....	94	Valves .....	101	Washer reservoir .....	41, 86, 93, 131
Temperature regulator .....	59	V-belts .....	124	Weights .....	132
Tempostat (automatic speed control) .....	53	Vehicle data .....	122, 123	Wheel, changing .....	104, 105
Theft protection .....	18, 19	Vehicle identification number .....	122	Wheel nuts .....	103
Tiptronic S .....	62 - 66, 131	Vehicle storage .....	92	Wheels, light alloy .....	91
Tool kit .....	98	Ventilation .....	58 - 60	Wheels, balancing .....	32, 100
Towing .....	120	Vents .....	58 - 60	Windows .....	90
Tow-starting .....	120			Windscreen .....	90
Transmission .....	125, 131			Windscreen washer system .....	52
Tripmeter .....	45, 48, 49			Windscreen wiper .....	52, 55
Tyre pressures .....	4, 99, 130			Windscreen wiper/washer stalk .....	52
Tyre replacement .....	101			Windstop .....	73 - 78
Tyres and tyre care .....	8, 99 - 101, 128, 129			Winter operation .....	93, 94
Tyre tread .....	100			Winter tyres .....	93, 94, 101, 128 - 130
				Wipe interval .....	52